 Z-Laser Optoelektronik GmbH Merzhauser Str. 134 D-79100 Freiburg Tel.: (0761)29644-44 Fax: (0761)29644-55/56	Product <b>ZFSM</b>	Date: <b>2017.01.24</b>	Page: <b>1 of 64</b>
	Advanced Information <b>Document-ID: UI-ZL-120005-2.0-2017-01-24</b>		Author: <b>TR</b>



PLEASE READ THE ENTIRE MANUAL BEFORE ATTEMPTING TO OPERATE THIS PRODUCT.

**OPERATING THIS PRODUCT USING PROCEDURES OTHER THAN THOSE SPECIFIED HEREIN MAY RESULT IN HAZARDOUS RADIATION EXPOSURE OR FAILURE.**

AVOID EXPOSURE TO DIRECT OR SCATTERED RADIATION FROM THE LASER.

**It is extremely important to follow laser safety rules and wear appropriate protective eyewear when working around these lasers. As a general rule, you should avoid eye or skin exposure to direct or scattered radiation from these lasers.**

All laser safety-warning labels are provided on the Unit and comply with IEC 60825-1

This Product is in full compliance with the European IEC 60825-1 and the United States CDRH laser Safety Regulations.

CAUTION-

**Use of controls or adjustments or performance of procedures other than those specified herein may result in hazardous radiation exposure.**

 Z-Laser Optoelektronik GmbH Merzhauser Str. 134 D-79100 Freiburg Tel.: (0761)29644-44 Fax: (0761)29644-55/56	Product <b>ZFSM</b>	Date: <b>2017.01.24</b>	Page: <b>2 of 64</b>
	Advanced Information <b>Document-ID: UI-ZL-120005-2.0-2017-01-24</b>		Author: <b>TR</b>

Revision	Date	Editor	Changes
0.1	13/04/13	Ruhnau	Initial Version – advanced information (Preliminary)
0.2	13/06/13	Ruhnau	Added housed versions and optics
0.3	18/06/13	Faulkner	Corrections for English
0.4	25/06/13	Ruhnau	Small corrections and add-ons
0.5	01/07/13	Ruhnau	Corrected minor items for early customers
0.6	03/07/13	Ruhnau	Spec and command update
0.7	05/07/13	Ruhnau	System status updated and cleaned up
0.8	10/07/13	Ruhnau	Added AddOn module section and safety functions
0.9	23/07/13	Faulkner	Corrections for English
1.0	28/08/13	Ruhnau	Added Optics and Measurements
1.1	26/11/13	Ruhnau	Cleanup and Fiber details
1.2	20/12/13	Ruhnau	System Specs and CRC-Examples
1.3	20/01/14	Ruhnau	Enhanced "GET_CALIBRATED_LASER" command
1.4	11/04/14	Ruhnau	Enhanced "SET_MODE" command
1.6	27/01/15	Ruhnau	Safety diagram and additional information
1.7	17/03/15	Ruhnau	Changed text for set_customer_service_mode command
2.0	24/01/17	Ruhnau	Added laser classification and fiber specs

 Z-Laser Optoelektronik GmbH Merzhauser Str. 134 D-79100 Freiburg Tel.: (0761)29644-44 Fax: (0761)29644-55/56	Product <b>ZFSM</b>	Date: <b>2017.01.24</b>	Page: <b>3 of 64</b>
	Advanced Information <b>Document-ID: UI-ZL-120005-2.0-2017-01-24</b>		Author: <b>TR</b>

<b>1.</b>	<b>Introduction.....</b>	<b>5</b>
1.1	About this Document .....	5
1.2	Application and Benefits of Fiber Coupled Lasers .....	6
1.3	Upon Receiving the Delivery .....	7
1.4	Handling of the product .....	9
1.5	Assembly .....	10
1.6	System.....	10
1.6.1	Laser Driver Unit (LDU).....	11
1.6.2	User Interface .....	12
<b>2.</b>	<b>Optics .....</b>	<b>12</b>
2.1	Line generator .....	12
2.2	Micro line generator.....	12
<b>3.</b>	<b>Fiber and Connector .....</b>	<b>12</b>
<b>4.</b>	<b>Operating the laser module.....</b>	<b>14</b>
4.1	Power supply .....	15
4.2	Electrical interfaces .....	16
4.3	Serial Interface .....	21
4.3.1	RS232 Interface:.....	21
4.3.2	I2C Interface:.....	21
4.3.3	List of read telegrams:.....	24
4.3.4	List of write telegrams: .....	29
4.3.5	Communication Procedures .....	32
4.3.6	Communication Status .....	32
4.4	System Status .....	32
4.5	How to control the laser.....	37
4.5.1	Static laser output power via I2C.....	38
4.5.2	Failure Output – System Shutdown.....	38
4.5.3	Warning Output .....	38
4.6	LED status indication.....	38
4.7	Typical operating errors.....	39
<b>5.</b>	<b>Safety functions.....</b>	<b>39</b>
5.1	Diagnosis and security functions.....	42
<b>6.</b>	<b>AddOn Functions .....</b>	<b>46</b>
6.1	Pulse Generator .....	46
6.1.1	Modes of pulsed operation .....	46
6.1.2	Functional Safety.....	47
6.1.3	Programming the pulse generator.....	48
6.1.4	Example Pulse Patterns .....	51
6.2	USB Interface .....	52
6.3	TEC Module.....	52
<b>7.</b>	<b>Drawings .....</b>	<b>53</b>
7.1	Laser Module.....	53
7.2	Standard barreled optics .....	53

 Z-Laser Optoelektronik GmbH Merzhauser Str. 134 D-79100 Freiburg Tel.: (0761)29644-44 Fax: (0761)29644-55/56	Product <b>ZFSM</b>	Date: <b>2017.01.24</b>	Page: <b>4 of 64</b>
	Advanced Information <b>Document-ID: UI-ZL-120005-2.0-2017-01-24</b>		Author: <b>TR</b>

<b>8.</b>	<b>Product Labelling .....</b>	<b>55</b>
<b>9.</b>	<b>Product Warranty .....</b>	<b>55</b>
<b>10.</b>	<b>Service .....</b>	<b>55</b>
<b>11.</b>	<b>Disposal .....</b>	<b>56</b>
<b>12.</b>	<b>In the case of a damage .....</b>	<b>56</b>
<b>13.</b>	<b>Measurements .....</b>	<b>57</b>
13.1	Power Stability (Example) .....	57
13.2	Optical characteristics (Example) .....	57
13.3	Errata .....	58
13.4	Laser classification .....	58
<b>14.</b>	<b>Declaration of Conformity .....</b>	<b>59</b>
<b>15.</b>	<b>Glossary .....</b>	<b>60</b>
<b>16.</b>	<b>Laser Safety .....</b>	<b>60</b>

 Z-Laser Optoelektronik GmbH Merzhauser Str. 134 D-79100 Freiburg Tel.: (0761)29644-44 Fax: (0761)29644-55/56	Product <b>ZFSM</b>	Date: <b>2017.01.24</b>	Page: <b>5 of 64</b>
	Advanced Information <b>Document-ID: UI-ZL-120005-2.0-2017-01-24</b>		Author: <b>TR</b>

## 1. Introduction

The “ZFSM” fiber laser module is a customized laser module for integration into industrial products. It is offered as a “bulk” module (i.e. PCB) or as a module within housing. Read the following user instructions carefully to learn how to use and operate it as designed.

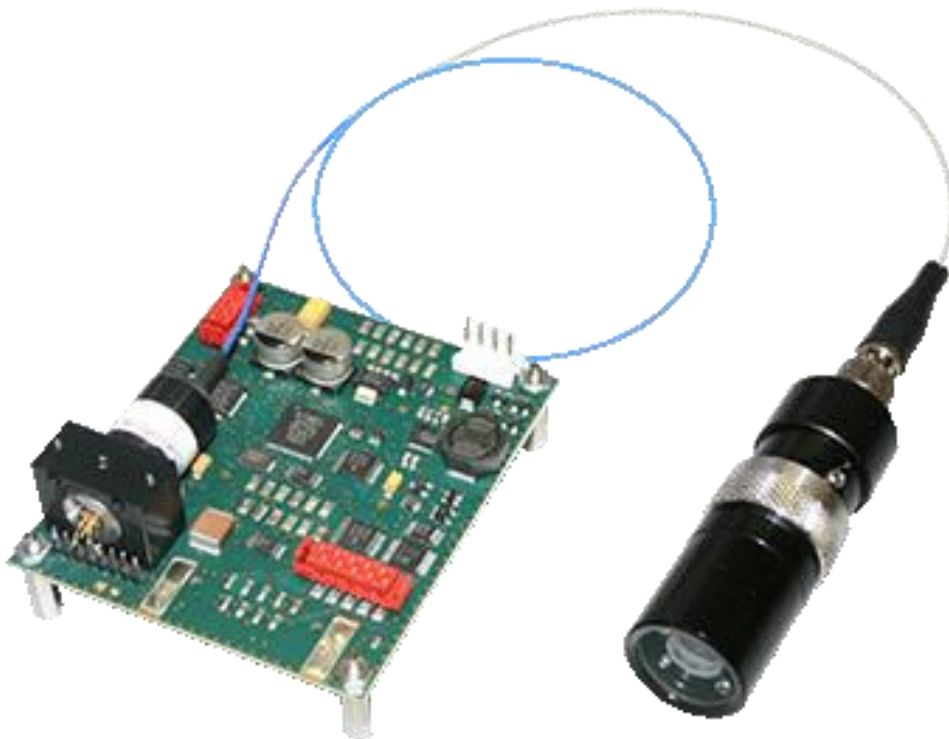

### 1.1 About this Document

This is a users’ manual in a preliminary version. Some descriptions of the ZFSM product may not be clear enough or may suffer a lack of details. At the time this document was issued some properties and some product options were not yet released in their final form. Both, the description and the product itself keep evolving based on customer feedback and ongoing product improvement.

Special product configurations targeting for safety critical applications are supported. This document describes both, normal and safety enabled configurations, however when this results in different behavior it is indicated with the “SFTY” or the “NON-SFTY” notifier respectively.

Please read chapter 13.3 “Errata” for non-compliances with to the specification.

 Z-Laser Optoelektronik GmbH Merzhauser Str. 134 D-79100 Freiburg Tel.: (0761)29644-44 Fax: (0761)29644-55/56	Product <b>ZFSM</b>	Date: <b>2017.01.24</b>	Page: <b>6 of 64</b>
	Advanced Information <b>Document-ID: UI-ZL-120005-2.0-2017-01-24</b>		Author: <b>TR</b>

## 1.2 Application and Benefits of Fiber Coupled Lasers

Fiber coupled laser sources have a couple of unique advantages over free launching laser sources for precision projection applications. With optical fibers some well proven technologies and components can be leveraged such as highly precise and concentric ceramics ferrules. They provide a perfect reproducibility of optical adjustments even after disconnecting and reconnecting the fiber to the optics module.

Optical single mode fibers provide a mode-cleaned ( $M^2 < 1.05$ ) and perfect Gaussian light emitter at the fiber tip. The result is a very small (3...4 $\mu\text{m}$ ) light source that is perfectly circular and has a small and constant numerical aperture (NA). This fiber-coupled laser source is by far the best prerequisite for many optical design considerations and for many adjustment requirements.

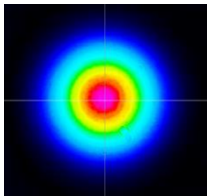

Picture: a perfectly round an Gaussian beam profile from a fiber coupled laser emitter

For some applications it is an advantage to decouple the laser diode with its driver electronics from the projection optics because the optics head has to be placed in extreme environmental conditions (heat, solvents...). Other applications might benefit from driving two optics heads by the same laser source. This can be done with a standard fiber splitter component.

The transport of the light through an optical fiber brings in some side effects though: the bend radius of the fiber has an impact on the transport efficiency. The output power varies slightly when the fiber is moved or repositioned. At the same time the polarization of the laser light is slightly dependent on the bend radius and on the temperature of the fiber. Ideally the fiber is mounted statically.

 Z-Laser Optoelektronik GmbH Merzhauser Str. 134 D-79100 Freiburg Tel.: (0761)29644-44 Fax: (0761)29644-55/56	Product <b>ZFSM</b>	Date: <b>2017.01.24</b>	Page: <b>7 of 64</b>
	Advanced Information <b>Document-ID: UI-ZL-120005-2.0-2017-01-24</b>		Author: <b>TR</b>

### 1.3 Upon Receiving the Delivery

Upon receiving this delivery, please carefully check the product for potential damage. If you discover any damage please report it immediately to Z-LASER. In the case of physical damage do not operate the product!

This shipment contains the following parts:

- 1 RGB fiber laser module (optionally in housing) with attached laser safety sticker, (picture below shows a bulk module with attached barrelled optics module)
- Optional AddOn Modules (e.g. pulse generator, USB interface, TEC)
- 1 user's manual and safety instructions (eventually sent electronically)
- optionally an evaluation kit is available for bulk configurations of ZFSM

If any of these components are missing, please contact Z-LASER and do not try to operate the product!

Save the shipping box and packing material for further shipping needs.



### CAUTION NOTE

Please note that the Laser module is sensible to Electro Static Discharge. So please take special care for ESD protection.

 Z-Laser Optoelektronik GmbH Merzhauser Str. 134 D-79100 Freiburg Tel.: (0761)29644-44 Fax: (0761)29644-55/56	Product <b>ZFSM</b>	Date: <b>2017.01.24</b>	Page: <b>8 of 64</b>
	Advanced Information <b>Document-ID: UI-ZL-120005-2.0-2017-01-24</b>		Author: <b>TR</b>

The “ZFSM” fiber laser module is a customized laser module for integration into industrial products. It is offered as a “bulk” module (i.e. PCB) or as a module within housing. Read the following user instructions carefully to learn how to use and operate it as designed.

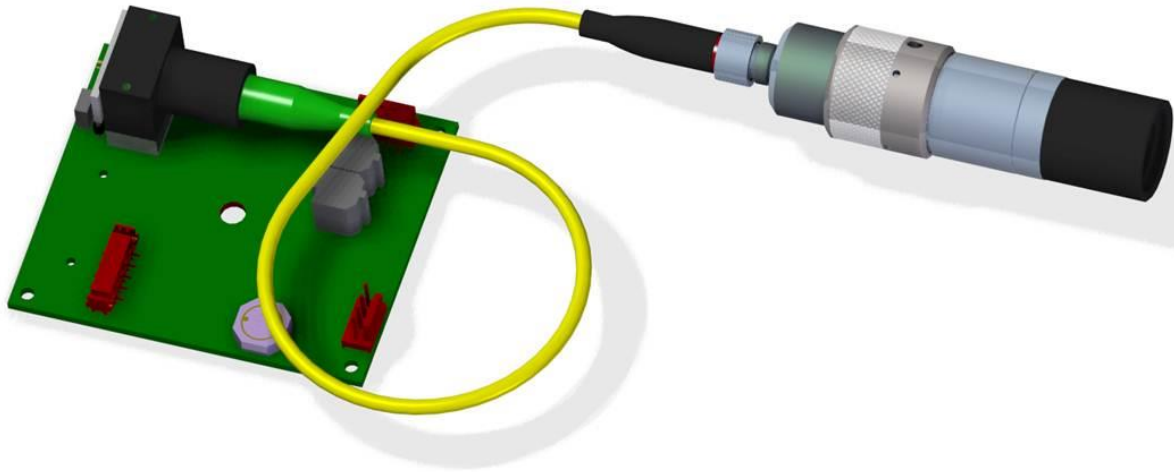

**Picture 1** The „ZFSM“ Module seen from above with a standard line optics.



**Picture 2** An active, or very good passive, cooling capability must be provided and attached to the marked cooling plane. Any sort of condensation must be prevented though. **Attention: prevent to expose the contact side of the laser diode to any sort of mechanical stress. Otherwise suffer severe damages and malfunction are likely to occur.**

 Z-Laser Optoelektronik GmbH Merzhauser Str. 134 D-79100 Freiburg Tel.: (0761)29644-44 Fax: (0761)29644-55/56	Product <b>ZFSM</b>	Date: <b>2017.01.24</b>	Page: <b>9 of 64</b>
	Advanced Information <b>Document-ID: UI-ZL-120005-2.0-2017-01-24</b>		Author: <b>TR</b>

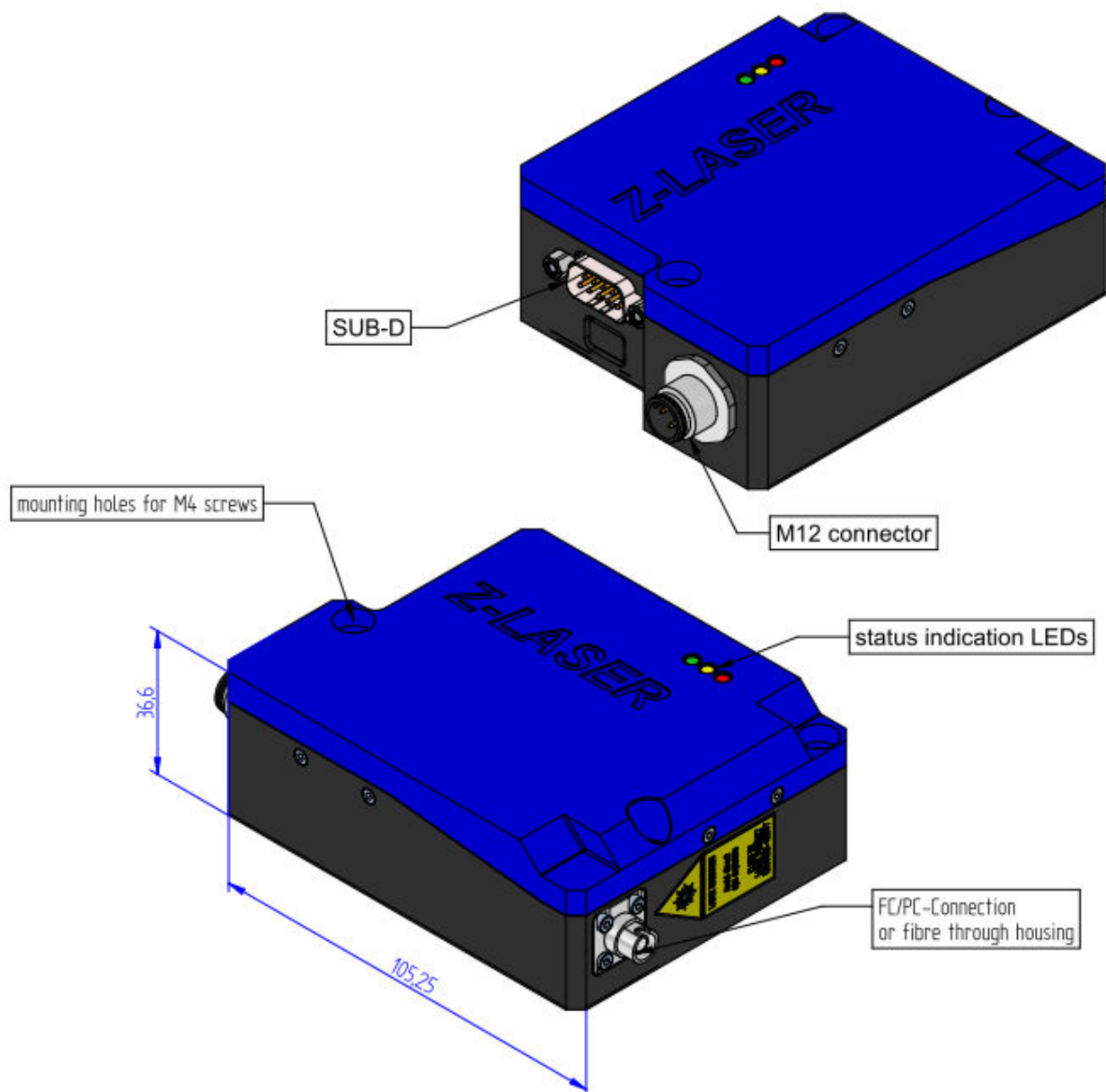

**Picture 3 ZFSM inside housing (optional)**

## 1.4 Handling of the product

The “ZFSM” module should be handled with the outmost care. It has no special protection measures against environmental influences, so mechanical shocks and vibrations should be prevented and it should not be exposed to dust, fluids, humidity and heat.

Bulk versions of ZFSM are very sensitive to electromagnetic influences. A correct and reliable function can only be maintained under well controlled environmental conditions. No mechanical stress must be put on any part of the PCB and its components.

 Z-Laser Optoelektronik GmbH Merzhauser Str. 134 D-79100 Freiburg Tel.: (0761)29644-44 Fax: (0761)29644-55/56	Product <b>ZFSM</b>	Date: <b>2017.01.24</b>	Page: <b>10 of 64</b>
	Advanced Information <b>Document-ID: UI-ZL-120005-2.0-2017-01-24</b>		Author: <b>TR</b>

Please be certain that the fiber terminal is always protected by the attached optics or a protection cap. Any exposure to dust or dirt will severely damage the fiber. Clamping and Bending of the Fiber must be avoided.

**ZFSM configurations with laser wavelengths below 500nm have air gap terminated fiber tips. So they must not be touched. Cleaning or other handling will immediately destroy the fiber.**

The control electronics of the “ZFSM” module provides active and passive protection against ESD but proper handling is essential. Care must be taken regarding the correct electrical connection; the instruction for correct electrical connection is found in section 4 “Operating the laser module”.

Only the top plane of the laser fiber coupler housing is prepared to be used for assembly (see Picture 2 above). Please make sure the contact side of the laser diode is not touched and not exposed to any mechanical force.

It is very important that the protective cap on the optical fiber output be mounted whenever no optics module is attached. The optical output is extremely sensitive to all types of pollution like dust, fluids, finger tips, etc. Removing the protective cap and attaching an optical fiber should be done in a clean room environment. Operating the “ZFSM” module with the open optical output is not recommended and might lead to damaging the system.

Please contact the Z-Laser service department in case of uncertainties.

## 1.5 Assembly

The “ZFSM” module should be operated with sufficient cooling capabilities. While it is possible to power up the module and transmit various serial communication telegrams without any special cooling, it is strongly recommended not to switch on the laser sources without a sufficient active or passive cooling system attached to the cooling plane (Take care for sufficient heat conductivity of the mounting).

**When using an active cooling system (water cooling, Peltier cooling,...) any sort of condensing humidity must be inhibited. Condensation can occur inside the fiber coupler and thus destroy the coupling efficiency in short time.**

For any laser operation, please keep in mind that high temperatures decrease the lifetime of laser diodes significantly.

The output fiber must be disconnected from the optics (and re-connected) under clean room conditions. Any pollution will damage the ZFSM module.

Electrical power supply and operation control signaling must be provided according to instructions given in this document.

Please do not disassemble the ZFSM fiber laser module.

## 1.6 System

The core component of ZFSM is the laser driver unit (LDU) with integrated micro controller (MCU) and a fiber coupled laser diode. The LDU provides various user interfaces and power

 Z-Laser Optoelektronik GmbH Merzhauser Str. 134 D-79100 Freiburg Tel.: (0761)29644-44 Fax: (0761)29644-55/56	Product <b>ZFSM</b>	Date: <b>2017.01.24</b>	Page: <b>11 of 64</b>
	Advanced Information <b>Document-ID: UI-ZL-120005-2.0-2017-01-24</b>		Author: <b>TR</b>

supply options. Major customizations are realized via AddOn PCB's for the Enhancement Port of the LDU.

Feature	Requirement	Comment	Reference
Operating Temperature	0°C ... +50°C (Case Temperature of the laser diode in a „Bulk” Version)  -10°C... +50°C (Case temperature for a housed Version)	<b>Attention: the LDU will switch off the laser when the temperature exceeds the specified limits</b>	
Storage Temperature	-40°C - +85°C	Ambient Temperature	
Humidity	95% non-condensing		
Overall Power Dissipation	< 4 W (for a “bulk” version)  < 20 W (for a housed version)	Worst case condition in CW mode. Depending on laser diode and operating voltage.	
Supply Voltage (VCC)	4.5 ... 30 VDC	Cost Down versions running at 5 VDC are optionally available	
Max Operating Current	< 1.0 A (for a “bulk” version)  < 4.0 A (for a housed version)		
Supported LD		Contact Z-Laser Sales Dpt.	
Maximum power at end of fibre	50 mW (red, IR) 20 mW (green) 40 mW (blue)	Depending on Laser-Diode, please contact Z-Laser	
Power stability at end of fibre	< ± 1% in steady state (1h, T=const, no changes of the fiber bending) < ± 2.5 % over entire temperature range < ± 10% over entire lifetime	Depending on Laser-Diode	
Bend Radius of Fiber	Not smaller than 30 mm	Other specs on request	
Laser safety class	3B	Depending on laser diode. Defined for laser power out of the fiber <b>Attention: reducing the intensity via Analog Modulation (X2.4) does not change the laser classification</b>	
MTTF (constant operation)	>10000 hours @ 25 °C diode case	Limited by the laser diode.	

### 1.6.1 Laser Driver Unit (LDU)

The laser driver unit incorporates the core functionality and the main intelligence of the laser system. It is built on a single PCB that provides the fiber coupled laser diode.

 Z-Laser Optoelektronik GmbH Merzhauser Str. 134 D-79100 Freiburg Tel.: (0761)29644-44 Fax: (0761)29644-55/56	Product <b>ZFSM</b>	Date: <b>2017.01.24</b>	Page: <b>12 of 64</b>
	Advanced Information <b>Document-ID: UI-ZL-120005-2.0-2017-01-24</b>		Author: <b>TR</b>

- Two serial two-wire communication interfaces (TWI) are provided (RS232 and I2C slave interface).
- Ethernet and USB communication is provided optionally (USB communication comes with optional USB power supply)
- Peltier cooling controllers (TEC) are optionally available.
- High standards reg. functional safety by a MCU (MMCU) running a sophisticated laser driver firmware and a secondary MCU (SMCU) for pure surveillance and system integrity checks.
- Support for multiple cascaded LDU's is available. LDU's can be configured to work as master or slave instances. Slaves are running under the master's command via an Internal Two Wire Interface (TW).

## 1.6.2 User Interface

The LDU has two external user interfaces, X1 and X2. Both are available for OEM implementations. The LDU can be configured with either.

For housed versions X1 is laid out as an interface to a standard 9-pin SubD connector, for bulk versions an internal X1 terminal is available that is denoted X1i. Whenever this document refers to X1 the internal X1i is meant for bulk versions.

For housed versions X2 is laid out as an alternative PWR/GND connector with standard M12 compatibility, for bulk versions an internal X2 terminal is available that is denoted X2i. Whenever this document refers to X2 the internal X2i is meant for bulk versions.

## 2. Optics

A wide range of laser types at many different wavelengths and laser power levels are available for ZFSM. Some major configurations are documented here; custom configurations are documented in specification sheets and in chapter 13.

### 2.1 Line generator

(TBD)

### 2.2 Micro line generator

(TBD)

## 3. Fiber and Connector

 Z-Laser Optoelektronik GmbH Merzhauser Str. 134 D-79100 Freiburg Tel.: (0761)29644-44 Fax: (0761)29644-55/56	Product <b>ZFSM</b>	Date: <b>2017.01.24</b>	Page: <b>13 of 64</b>
	Advanced Information <b>Document-ID: UI-ZL-120005-2.0-2017-01-24</b>		Author: <b>TR</b>

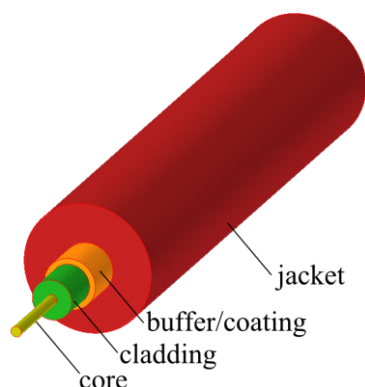

The core diameter of the fiber is:

- 3µm for blue, terminated with a high power, mechanically cleaved, End-cap connector
- 3.5µm for green,
- 4µm for red,
- 5µm for NIR.

The jacket is 3mm for standard configurations (900µm on request)



The AR-coated FC/PC connector type is generally not well suited for fiber-to-fiber connections. The AR coating is exposed to mechanical contacts and inherently very sensitive to scratches and other damages. It is needed however to reduce the level of back reflections. Its most important advantage is to deliver a perfectly round and concentric laser beam.

Blue and green ZFSM versions can not be used for fiber-to-fiber connection. Due to an end-cap termination the coupling efficiency will be very poor.

Feature	Requirement	Comment
Connector Type	AR-coated FC/PC - w/2,5mm connector	Without metal flange on request. Other connectors on request
Numerical Aperture		
Bend Radius	Min 30mm	Smaller bend radius will lead to loss of power or various distortions
Fiber diameter	3mm outer diameter (PVC)	900µm on request
Ferrule type	126µm inner diameter (zirconia ferrule) 2mm outer diameter	
Fiber type	125µm outer diameter of cladding	
Fiber length	500mm +/- 50mm	

 Z-Laser Optoelektronik GmbH Merzhauser Str. 134 D-79100 Freiburg Tel.: (0761)29644-44 Fax: (0761)29644-55/56	Product <b>ZFSM</b>	Date: <b>2017.01.24</b>	Page: <b>14 of 64</b>
	Advanced Information <b>Document-ID: UI-ZL-120005-2.0-2017-01-24</b>		Author: <b>TR</b>

## 4. Operating the laser module

The “ZFSM” module is shipped with a pre-set optical output power for each sub module. The pre-set power values are regarded the maximum power values – or 100% of the optical output values that can be gained from each module. (Please refer to Chapter 4.3.4)

Please be certain that before operating the laser module you have taken all aspects of laser safety into consideration. (Refer to Chapter 15). Keep the safety cap closed at the fiber output or mount it in fixed position in front of a photo detector. Make sure that no human being is accidentally exposed to laser radiation.

To identify the right connectors please refer to Chapter 0 (Drawings)

First steps to a basic operation of the laser module could be as follows:

1. Be certain that the “ZFSM” module is assembled correctly and mounted on a proper heat sink. Mounting must be flat and air gaps should be avoided by using heat sink compound.
2. Prepare a proper cabling for X1 and X2, refer to chapter 4.2 for details
3. Connect a 5 to 24 VDC power supply to the X1 or X2 connector. Be sure it can source more than 20 Watt if a housed version is powered or if a TEC AddOn module is being used.
4. Switch on the laser (green LED starts blinking)
  - a. For “ZFSM” versions for safety critical applications (marked as “SFTY”) → Connect X1 and X2 and apply appropriate TWI (I2C or RS232) telegrams to enable the laser module and switch in on.
    - System\_enable → active (high)
    - SET\_PASSWD command
    - SET\_LASER (On) command (orange LED should turn on)
    - Use digital modulation or pulse trigger (X2.2) input to control the laser
(For details refer to chapters 4.3 and 4.4)
  - b. For other “ZFSM” versions → Connect X2.2 and apply appropriate signals to the digital trigger input to switch the laser on.

**Attention: reducing the laser intensity via TWI telegrams or the control interface (X2.4) does not change the laser safety classification**

 Z-Laser Optoelektronik GmbH Merzhauser Str. 134 D-79100 Freiburg Tel.: (0761)29644-44 Fax: (0761)29644-55/56	Product <b>ZFSM</b>	Date: <b>2017.01.24</b>	Page: <b>15 of 64</b>
	Advanced Information <b>Document-ID: UI-ZL-120005-2.0-2017-01-24</b>		Author: <b>TR</b>

## 4.1 Power supply

The “ZFSM” Laser module can be supplied by 5-30 VDC. The Supply inputs on X1 and X2 are protected against excessive inrush currents, reverse polarity and transient over voltages.

They both are supplying power to the ZFSM system in the same way; however they are isolated by diodes to each other to prevent short currents.

There is no ON-switch. When supply voltage is applied, the module starts powering up and self-testing the entire system and verifying the safety architecture. Please refer to Chapter 4.4.

System integrity tests are only conducted after powering up the “ZFSM” laser module. To prevent undetected accumulations of failures, the module should be power cycled on a regular base, e.g. once every 24h. An integrated ON-time counter can be read out via TWI telegrams and indicates the time passed by since the last system integrity test.

It is not recommended to disconnect the supply voltage from a running system, uncompleted TWI transmissions might lead to undefined settings.

A controlled power-down procedure initiated by the appropriate TWI command ensures that all important settings and parameters are stored in a safe way within the non-volatile memory. The laser sources and all other system resources are powered down in a way that prevents intermediate light emission or storing of energy in capacitors and inductors.

**Attention:** The housing of the laser diode bears the cathode potential. When mounting it on a cooling device, please take care for a proper electrical isolation

 Z-Laser Optoelektronik GmbH Merzhauser Str. 134 D-79100 Freiburg Tel.: (0761)29644-44 Fax: (0761)29644-55/56	Product <b>ZFSM</b>	Date: <b>2017.01.24</b>	Page: <b>16 of 64</b>
	Advanced Information <b>Document-ID: UI-ZL-120005-2.0-2017-01-24</b>		Author: <b>TR</b>

## 4.2 Electrical interfaces

ZFSM has two electrical interfaces (X1 and X2) which can basically be operated independently from each other. To use the full functionality however, both can be used at the same time. Housed versions of ZFSM are contacted via a Sub-D connector for X1 and a 4-pin M12 connector for X2. OEM versions alternatively offer an internal connector for X1 and X2 (marked as X1i and X2i, see below).

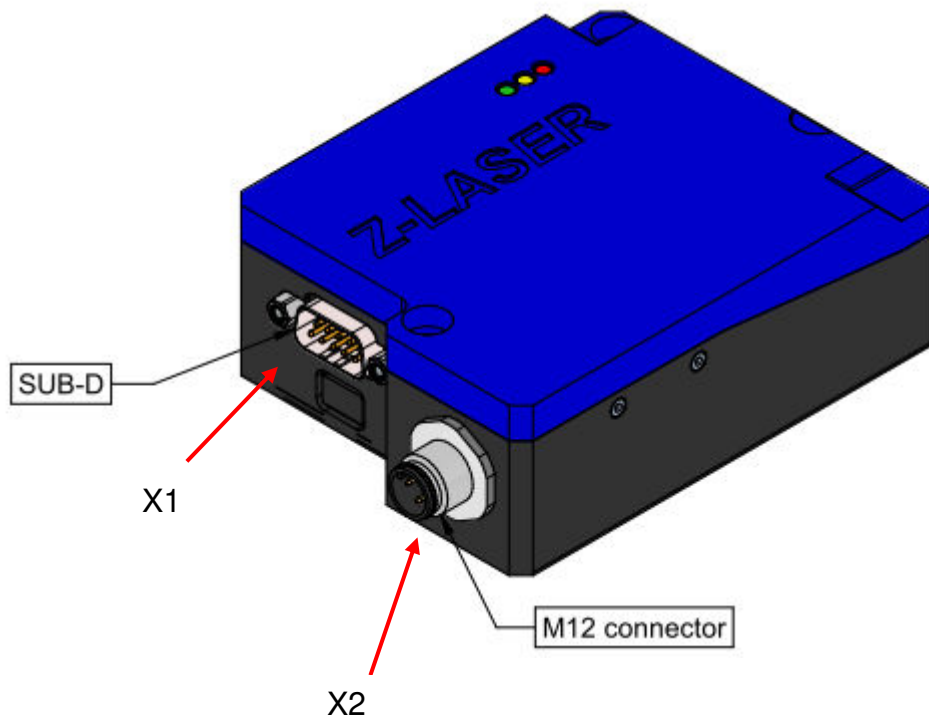

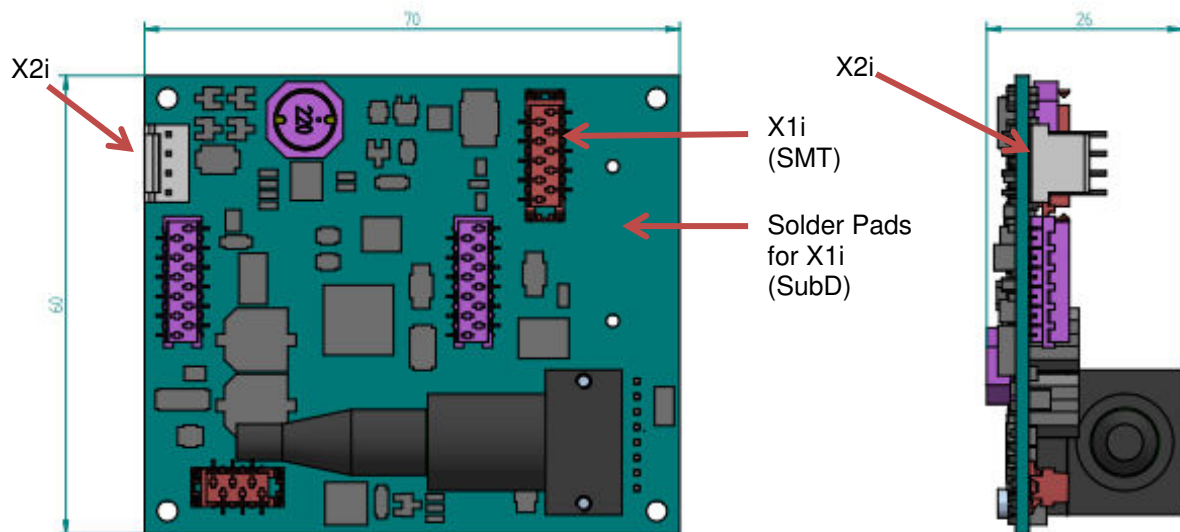

Industrial standard connectors at a housed version of ZFSM

 Z-Laser Optoelektronik GmbH Merzhauser Str. 134 D-79100 Freiburg Tel.: (0761)29644-44 Fax: (0761)29644-55/56	Product <b>ZFSM</b>	Date: <b>2017.01.24</b>	Page: <b>17 of 64</b>
	Advanced Information <b>Document-ID: UI-ZL-120005-2.0-2017-01-24</b>		Author: <b>TR</b>

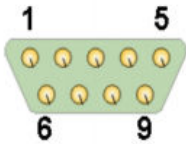

Cable connectors at a bulk version of ZFSM (X1i and X2i might be relocated to AddOn modules. See section 6 for more details)

Feature	Reference
<p><b>X1 (9 pin SubD):</b></p> <p>No physical SubD connector is placed on the LDU PCB, a bus tap for the X1i bus is provided as well as a Micro-MaTch 10pol Female SMT Connector w. Latch &amp; Polarization (Würth WR-MM 690367291076). An external SubD connector can easily be connected this way.</p> <p>The pin assignment on the X1i Micro-MaTch connector supports the direct cabling to the X1 SubD connector of housed versions.</p> <div style="display: flex; align-items: center; margin-top: 10px;">  <div style="margin-left: 20px;"> <p><b>SubD for housed versions of ZFM</b></p> </div> </div> <ul style="list-style-type: none"> <li>X1.1 System-Shutdown (failure status, open collector, active low)</li> <li>X1.2 Tx-D (RS-232 wire - non isolated signal related to GND )</li> <li>X1.3 Rx-D (RS-232 wire - non isolated signal related to GND )</li> <li>X1.4 Early Warning (e.g. over temperature, open collector, active low)</li> <li>X1.5 GND (Signal GND)</li> <li>X1.6 VCC (4.5... 30 VDC)</li> <li>X1.7 System-Enable (5V TTL signaling level, active high)</li> <li>X1.8 SDA slave</li> <li>X1.9 SCL slave</li> </ul>	

 Z-Laser Optoelektronik GmbH Merzhauser Str. 134 D-79100 Freiburg Tel.: (0761)29644-44 Fax: (0761)29644-55/56	Product <b>ZFSM</b>	Date: <b>2017.01.24</b>	Page: <b>18 of 64</b>
	Advanced Information <b>Document-ID: UI-ZL-120005-2.0-2017-01-24</b>		Author: <b>TR</b>

**SMT Connector on LDU-PCB** (Micro-MaTch 10pol Female SMT Connector e.g. Würth→ WR-MM 690367291076)

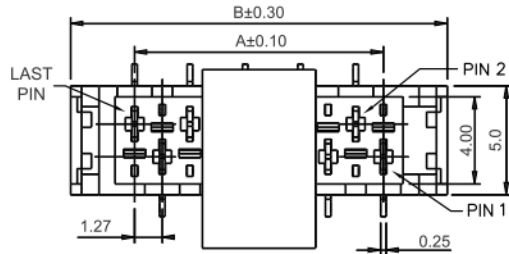



- X1i.1 System-Shutdown (failure status, open collector, active low)
- X1i.2 VCC (4.5... 30 VDC)
- X1i.3 Tx-D (RS-232 wire - non isolated signal related to GND )
- X1i.4 System-Enable (5V TTL signaling level, active high)
- X1i.5 Rx-D (RS-232 wire - non isolated signal related to GND )
- X1i.6 SDA slave
- X1i.7 Early Warning (e.g. over temperature, open collector, active low)
- X1i.8 SCL slave
- X1i.9 GND (Signal GND)
- X1i.10 N.C.

Feature	Spec	Comment	Reference
VCC X1.6 (ext. SubD) X1i.2 (int. SMT)	4.5-30 VDC With Inrush current limiter and reverse polarity protection. Standard burst and surge protected.	Internally connected to 2.1  Please refer to Errata chapter (13.3)	
GND X1.5 (ext. SubD) X1i.9 (int. SMT)	Common ground	System Ground, please maintain proper connectivity	
System Shutdown X1.1 (ext. SubD) X1i.1 (int. SMT)	Open drain INOUT with integrated 10 kOhms pull-up resistor to the internal VCC	Active low signal that statically indicates all detected fatal failure conditions. <a href="#">External sources can shut down the LDU as well</a>	
System Enable X1.7 (ext. SubD) X1i.4 (int. SMT)	TTL INPUT signaling, bidirectional with internal 1 MegOhm pulldown and 10 kOhm pullup/pulldown switched by MCU  Vi_min: -0.5 Volt (abs. min) Vi_max: +6.5 Volt (abs. max) VIL_max: < +1.2 Volt VIH_min: > +2.8 Volt  Used only for "SFTY" configurations	Active high signal that statically enables the LDU, no laser operation is possible without an enabled system. No reverse polarity protection,  Leave unconnected for non-SFTY systems	

 Z-Laser Optoelektronik GmbH Merzhauser Str. 134 D-79100 Freiburg Tel.: (0761)29644-44 Fax: (0761)29644-55/56	Product <b>ZFSM</b>	Date: <b>2017.01.24</b>	Page: <b>19 of 64</b>
	Advanced Information <b>Document-ID: UI-ZL-120005-2.0-2017-01-24</b>		Author: <b>TR</b>

Early Warning X1.4 (ext. SubD) X1i.7 (int. SMT)	Open drain OUTPUT with integrated 10 kOhms pull-up resistor to the internal VCC	Active low signal that statically indicates all detected warning conditions as well as "system startup" status	
Txd X1.2 (ext. SubD) X1i.3 (int. SMT)	Active state: +3V...+15V Inactive state: -3V...-15V	ANSI/EIA/TIA-232-F-1997	
Rxd X1.3 (ext. SubD) X1i.5 (int. SMT)	Active state: +3V...+15V Inactive state: -3V...-15V	ANSI/EIA/TIA-232-F-1997	
SDA X1.8 (ext. SubD) X1i.6 (int. SMT)	3.3 Volt signal level (5V compatible)	No internal pullup resistor	
SCL X1.9 (ext. SubD) X1i.8 (int. SMT)	3.3 Volt signal level (5V compatible)	No internal pullup resistor	

Feature	Reference
<p><b>X2:</b></p> <p>The X2 connector provides a secondary supply connection for the 4.5-30 VDC power supply. It can be used when no 4.5-30VDC power supply is provided in the SubD connection, e.g. when more power is needed or in special OEM configurations. X2 provides modulation control pins (analog and digital) as well.</p>  <p>X2.1 VCC (4.5-30 Volt, I<sub>max</sub> &lt; 4 A)  X2.2 Digital-Modulation (TTL signaling level related to Signal-GND)  X2.3 GND  X2.4 Analog Modulation (0-2V signaling level related to Signal-GND)</p> <p>Attention: the "analog modulation" input has an internal pullup resistor. This leads to 100% of nominal laser power if the pin is not driven by an external source. As a side effect the laser is on with 100% of nominal laser power if the analog modulation input is directly connected to the digital modulation input.</p> <p><b>Attention: reducing the intensity via Analog Modulation (X2.4) does not change the laser classification</b></p> <p>X2 makes the "ZFSM" pin compatible to Z-Laser's ZM18 and ZM12 models. Housed versions of ZFSM have a M12 compatible industrial connector. Bulk versions are connected by the X2i MTA connector on the LDU.</p>	

 Z-Laser Optoelektronik GmbH Merzhauser Str. 134 D-79100 Freiburg Tel.: (0761)29644-44 Fax: (0761)29644-55/56	Product <b>ZFSM</b>	Date: <b>2017.01.24</b>	Page: <b>20 of 64</b>
	Advanced Information <b>Document-ID: UI-ZL-120005-2.0-2017-01-24</b>		Author: <b>TR</b>

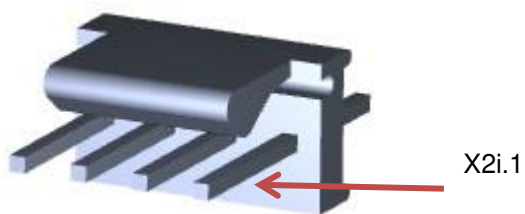
			
4POS MTA-100 (POLARIZED, NOTCHED, VERT, .100, TIN ) 640456-4 X2i.1 VCC (4.5-30 Volt, I <sub>max</sub> < 4 A) X2i.2 GND X2i.3 Digital-Modulation (TTL signaling level related to Signal-GND) X2i.4 Analog Modulation (0-2V signaling level related to Signal-GND)			
Feature	Spec	Comment	Reference
V+ X2.1 (ext. M12) X2i.1 (int. MTA)	4.5-30 VDC With Inrush current limiter and reverse polarity protection. Standard burst and surge protected.	Internally connected to X1.6	
V- X2.3 (ext. M12) X2i.2 (int. MTA)	GND	System Ground, please maintain proper connectivity	
Analogue Modulation X2.4 (ext. M12) X2i.4 (int. MTA)	Real time analog power control input  Linear range: 10%...100% of nominal laser power.  Resolution: < 10µW  Response Time < 10µs  Usable input range <b>0.0 .... 2.0 Volt</b>  Reverse polarity protected  Overvoltage protected up to 30 V  Internal Pullup Resistor leads to 100% of nominal laser power if undriven	“nominal” laser power adjusted by customer or absolute maximum power that has been calibrated at Z-Laser  <b>Attention: reducing the intensity via Analog Modulation (X2.4) does not change the laser classification</b>	
Digital Modulation (PWM) X2.2 (ext. M12) X2i.3 (int. MTA)	< 200 kHz (without overshoot)  PWM transmission error < ± 5% @ 10 kHz < ± 10% @ 100 kHz  PWM input with programmable polarity, TTL signaling: V <sub>IL_max</sub> : < +1.2 Volt V <sub>IH_min</sub> : > +2.8 Volt  Reverse polarity protected  Overvoltage protected up to 30 V	„PWM transmission error“: when a PWM signal at a 50% power level (duty cycle) is translated to a 45% laser power level – the transmission error is -10%. Typically the transmission error is caused by turn-on-delays of the laser diode.	

 Z-Laser Optoelektronik GmbH Merzhauser Str. 134 D-79100 Freiburg Tel.: (0761)29644-44 Fax: (0761)29644-55/56	Product <b>ZFSM</b>	Date: <b>2017.01.24</b>	Page: <b>21 of 64</b>
	Advanced Information <b>Document-ID: UI-ZL-120005-2.0-2017-01-24</b>		Author: <b>TR</b>

Pulse Mode (triggered by X2.2)	Trigger with programmable polarity, TTL edge signaling.  (for pulsed operation modes an AddOn module is available that relocates X2i)  Electrical specs as for digital modulation (see above)	This mode can be chosen via firmware settings or via TWI telegram. All details of the pulse shapes, timing and modes can be changed via TWI protocols.	
-----------------------------------	--	--	--

### 4.3 Serial Interface

The “ZFSM” module can be controlled by user commands being transmitted via a serial interface (TWI). Two transmission standards are supported on dedicated IO-Pins on X1, RS232 and I<sup>2</sup>C. The user can operate one of each or both in parallel (in that case I<sup>2</sup>C commands have the higher priority, i.e. are being processed). When the I<sup>2</sup>C interface is used, external pull-up resistors must be implemented.

*Note: not all implemented telegrams are documented due to low relevance to customer use cases. A full documentation is available on request. Please contact Z-Laser.*

#### 4.3.1 RS232 Interface:

Up to 57.600 Baud

No parity

1 Stopbit

8 Data bits

Half duplex communication

*Every Sequence (read and write transmissions) must be terminated by an inactive phase of at least 2 ms and a successful transmission of the respective response by ZFSM.*

The serial interface protocol for RS232 telegrams is completely identical to I<sup>2</sup>C-telegrams. However no device-ID byte is transmitted when RS232 is used; see light green telegram byte for I<sup>2</sup>C transmissions below. So the given documentation refers to I<sup>2</sup>C but is valid for RS232 as well.

#### 4.3.2 I<sup>2</sup>C Interface:

The I<sup>2</sup>C communication interface is operated via SDA and SCL (X1.8/X1i.6 and X1.9/X1i.8) according to standardized physical I<sup>2</sup>C protocol definition up to 100 Kbit/s. No Pull-up resistors are implemented for both wires; this must be done on the host side. A proper GND reference of the applied signals has to be ensured. Signal-GND (X1.5) can be used for this.

Please refer to the original Philips specification that can be found at this URL:

<http://ics.nxp.com/support/documents/interface/pdf/i2c.bus.specification.pdf>

 Z-Laser Optoelektronik GmbH Merzhauser Str. 134 D-79100 Freiburg Tel.: (0761)29644-44 Fax: (0761)29644-55/56	Product <b>ZFSM</b>	Date: <b>2017.01.24</b>	Page: <b>22 of 64</b>
	Advanced Information <b>Document-ID: UI-ZL-120005-2.0-2017-01-24</b>		Author: <b>TR</b>

Feature	Reference										
<p>The default device-ID of the laser module is 0x88 (WR). It can be permanently re-programmed however (see below, always depicted in light green)</p>											
<p>Standard I2C Telegrams are supported; every I2C telegram contains a write transmission and one or more read transmission of a defined length.</p> <p>The write transmission contains the write-device-ID and 3 or more data bytes. At least a Command byte, a sub address byte (see TS) and a CRC byte for the telegram is transmitted. Optionally a data payload of one or more bytes can be inserted.</p> <p>The subsequent read transmission(s) contain the read-device-ID, a data payload of one or more data bytes and a CRC byte for the telegram. Every read transmission has a predefined number of bytes - for every SET command the read transmission contains the system status which indicates the success of the transmitted write telegram.</p> <p>For write telegrams the read transmission can be repeated multiple times until the status indicates a successful completion of the command processing (busy bit = 0)</p> <p>For read telegrams that cannot provide instantaneous data to return, the read transmission does not contain data payloads else then the system status followed by the CRC (data byte count = 0). To provide the expected transmission length, fill bytes are appended. This is indicated to the I2C host by an active "busy" flag in the system status byte (Bit 0 = 1). The read transmission can be repeated multiple times until the busy bit is reset (Bit 0 = 0) and valid data bytes are returned.</p> <p>Other circumstances where no data is returned:</p> <p>Error flag (bit 1 = 1) – e.g. the command byte has not been interpreted correctly</p> <p>NACK flag (bit 3 = 1) – e.g. premature new command received when previous command has not yet been executed successfully.</p> <table border="1" data-bbox="212 1541 1043 1659"> <tr> <td style="background-color: #c8e6c9;">WR-Device-ID</td> <td>CMD Byte</td> <td>ADR Byte</td> <td>Data Byte 0....N</td> <td style="background-color: #e0f7fa;">CRC-TGM</td> </tr> <tr> <td style="background-color: #c8e6c9;">RD-Device-ID</td> <td>System Status</td> <td>Data Byte 0....N</td> <td style="background-color: #e0f7fa;">CRC-TGM</td> <td>Fill Byte 0....N</td> </tr> </table> <p>Typical <u>data payload</u> configurations for write transmissions are as follows:</p>	WR-Device-ID	CMD Byte	ADR Byte	Data Byte 0....N	CRC-TGM	RD-Device-ID	System Status	Data Byte 0....N	CRC-TGM	Fill Byte 0....N	
WR-Device-ID	CMD Byte	ADR Byte	Data Byte 0....N	CRC-TGM							
RD-Device-ID	System Status	Data Byte 0....N	CRC-TGM	Fill Byte 0....N							

 Z-Laser Optoelektronik GmbH Merzhauser Str. 134 D-79100 Freiburg Tel.: (0761)29644-44 Fax: (0761)29644-55/56	Product <b>ZFSM</b>	Date: <b>2017.01.24</b>	Page: <b>23 of 64</b>
	Advanced Information <b>Document-ID: UI-ZL-120005-2.0-2017-01-24</b>		Author: <b>TR</b>

for simple commands	no Byte				
for safety critical simple commands	CRC-ADR				
for safety critical parameter settings	Parameter	CRC-PARM	CRC-ADR		
for safety uncritical parameter settings	Parameter				
for safety uncritical parameter settings	Parameter-Hi	Parameter-Lo			
for safety uncritical parameter settings	Parameter-1	Parameter-2	Parameter-3	Parameter-4	
for larger data payloads	Byte-Cnt (N)	Byte 0	....	Byte N	

**The ADR byte** defines the sub address of a particular LDU within the system; the laser type mapping is documented in the user instruction and can be queried with a dedicated I2C telegram.

0x00 for the master LDU (or when there is only one LDU in the system)

0x01 for the first sub LDU module

0x02 for the second sub LDU module

...

0xFF for the entire system (all sub modules), only used for WRITE telegrams.

Some I2C telegrams address the whole system rather than sub modules. For these (only for these) the sub address 0xFF must be used. The master module incorporates a broadcast function to maintain system settings throughout all sub modules. When only one LDU is in the system both sub addresses, 0x0 and 0xFF can be used for system related telegrams.

When the sub address 0xFF is used for other I2C telegrams an ERROR is indicated. READ telegrams don't support the sub address 0xFF neither.

**The CRC calculation** is based on these Polynomials:

**Polynom 1 (ITU-T\_CRC8):**  
 $x^8 + x^2 + x + 1$  (0x07)

**Polynom 2 (CCITT-CRC8):**  
 $x^8 + x^5 + x^4 + 1$  (0x31)

Initial Value = 0xFF (direct)

Final XOR Value = 0

Reverse Data Bytes = YES

Reverse CRC results = YES

(note that  $x^8$  is added to indicate the MSB of the polynomial, only 8 LSB's are used for the calculation)

**"Polynom-1"** is used for calculating "CRC-PARM" and "CRC-ADR" for the decryptions of safety critical telegrams this polynomial resides only in the SMCU.

CRC-PARM refers to the parameter byte(s) of the data payload in safety critical

 Z-Laser Optoelektronik GmbH Merzhauser Str. 134 D-79100 Freiburg Tel.: (0761)29644-44 Fax: (0761)29644-55/56	Product <b>ZFSM</b>	Date: <b>2017.01.24</b>	Page: <b>24 of 64</b>
	Advanced Information <b>Document-ID: UI-ZL-120005-2.0-2017-01-24</b>		Author: <b>TR</b>

<p>telegrams</p> <p>CRC-ADR refers to the ADR byte in safety critical telegrams</p> <p>“<b>Polynom-2</b>” is used for calculating “CRC-TGM”. For the decryption of all telegrams this polynomial resides in the MMCU.</p> <p>CRC-TGM refers to the entire telegram except the I2C-device-ID.</p> <p>A simple CRC calculator is given here:  <a href="http://www.zorc.breitbandkatze.de/crc.html">http://www.zorc.breitbandkatze.de/crc.html</a></p>	
---	--

#### 4.3.3 List of read telegrams:

Feature		Reference																							
<p><b>GET_SYSTEM_STATUS</b> – reads the system status byte. The system status indicates the successful completion of the previous write transmission.</p> <table border="1" data-bbox="210 1048 852 1099"> <tr> <td>WR-Device-ID</td> <td>CMD (0x46)</td> <td>Sub Address</td> <td>CRC-TGM</td> </tr> </table> <table border="1" data-bbox="210 1111 692 1162"> <tr> <td>RD-Device-ID</td> <td>System Status</td> <td>CRC-TGM</td> </tr> </table> <p>(The Sub Address is redundant for this command because it must be 0x00 to address the master module which maintains the system status)</p> <p>Some Status Flags (Warning Class 2) will stay persistent until a GET_MODULE_STATUS Command is being issued:</p> <p>System Status Byte Codes:</p> <table border="1" data-bbox="194 1406 1259 1906"> <tr> <td>Bit 0</td> <td>Busy-Flag (1 = telegram not yet completely processed)</td> </tr> <tr> <td>Bit 1</td> <td>Telegram Error Flag (current telegram)</td> </tr> <tr> <td>Bit 2</td> <td>Not used</td> </tr> <tr> <td>Bit 3</td> <td>NACK-Flag (1 = telegram discarded, e.g. premature telegram)</td> </tr> <tr> <td>Bit 4</td> <td>Warning Class 2 Flag</td> </tr> <tr> <td>Bit 5</td> <td>Warning Class 1 Flag</td> </tr> <tr> <td>Bit 6</td> <td>Not used</td> </tr> <tr> <td>Bit 7</td> <td>System Error Flag (see ERROR Codes)</td> </tr> </table>		WR-Device-ID	CMD (0x46)	Sub Address	CRC-TGM	RD-Device-ID	System Status	CRC-TGM	Bit 0	Busy-Flag (1 = telegram not yet completely processed)	Bit 1	Telegram Error Flag (current telegram)	Bit 2	Not used	Bit 3	NACK-Flag (1 = telegram discarded, e.g. premature telegram)	Bit 4	Warning Class 2 Flag	Bit 5	Warning Class 1 Flag	Bit 6	Not used	Bit 7	System Error Flag (see ERROR Codes)	
WR-Device-ID	CMD (0x46)	Sub Address	CRC-TGM																						
RD-Device-ID	System Status	CRC-TGM																							
Bit 0	Busy-Flag (1 = telegram not yet completely processed)																								
Bit 1	Telegram Error Flag (current telegram)																								
Bit 2	Not used																								
Bit 3	NACK-Flag (1 = telegram discarded, e.g. premature telegram)																								
Bit 4	Warning Class 2 Flag																								
Bit 5	Warning Class 1 Flag																								
Bit 6	Not used																								
Bit 7	System Error Flag (see ERROR Codes)																								
<p><b>GET_MODULE_STATUS</b> – reads the module status byte. The module status indicates the status of a LDU module after the previous write transmission.</p>																									

 Z-Laser Optoelektronik GmbH Merzhauser Str. 134 D-79100 Freiburg Tel.: (0761)29644-44 Fax: (0761)29644-55/56	Product <b>ZFSM</b>	Date: <b>2017.01.24</b>	Page: <b>25 of 64</b>
	Advanced Information <b>Document-ID: UI-ZL-120005-2.0-2017-01-24</b>		Author: <b>TR</b>

WR-Device-ID	CMD (0x60)	Sub Address	CRC-TGM	
RD-Device-ID	System Status	4 Error bytes	4 Warn. bytes	CRC-TGM
(Status followed by CRC and trailing fill bytes when data can not be returned instantaneously)				
<b>Error Codes (MSB first) - can't be reset during runtime</b>				
Bit 0	ERROR_FLASH_CHECK			
Bit 1	ERROR_EEPROM_CHECK			
Bit 2	ERROR_RAM_CHECK			
Bit 3	ERROR_INTERRUPT_CHECK			
Bit 4	ERROR_WATCHDOG_CHECK			
Bit 5	ERROR_DAC_VERIFICATION			
Bit 6	ERROR_DAC_3			
Bit 9	ERROR_CMD_EXECUTION			
Bit 11	ERROR_SPI_ERROR			
Bit 12	ERROR_UART_ERROR			
Bit 14	ERROR_OVER_CURRENT			
Bit 16	ERROR_LD_OVERTEMP (massive over temperature of laser)			
Bit 17	ERROR_LD_UNDERTEMP			
Bit 18	ERROR_SHTDWN_DETECTED			
Bit 19	ERROR_RAM_VARIABLE			
Bit 20	ERROR_CALIBRATION_TABLE			
Bit 21	ERROR_HEARTBEAT_MISSING (MMCU-SMCU crosscheck)			
Bit 22	ERROR_PULSE_DURATION (laser-on phase for more than 1s)			
<b>Warning class 1 Codes – can't be reset during runtime</b>				
Bit 0	WARNING_1_OVER_24_HOURS_ONTIME			
<b>Warning class 2 Codes – can be reset during runtime</b>				
Bit 16	WARNING_2_INVALID_CMD_FRAME (cleared after GET_MODULE_STAUS command)			
Bit 17	WARNING_2_INVALID_MOD_ADDR FRAME (cleared after GET_MODULE_STAUS command)			
Bit 18	WARNING_2_CMD_OUT_OF_RANGE FRAME (cleared after GET_MODULE_STAUS command)			
Bit 19	WARNING_2_ACCESS_VIOLATION FRAME (cleared after GET_MODULE_STAUS command)			
Bit 20	WARNING_2_LD_OVERTEMP (moderate over temperature of laser) cleared upon lowering the temperature			
Bit 21	WARNING_2_LD_UNDERTEMP (cleared upon lowering the temperature)			
Bit 22	WARNING_2_END_OF_LIFE (stays persistent upon detection of failure)			
<b>GET_OPERATION_STATUS</b> – reads the system operation status byte. The operation status indicates the status of the system acc. to 4.4. Please note these inconsistencies:				
<ul style="list-style-type: none"> <li>- the OPERATION Status cannot be queried by this command.</li> <li>- the SYSTEM_STARTUP Status cannot be read, when it is active.</li> <li>- the POWERDOWN Status cannot be read, when it is active.</li> </ul>				

 Z-Laser Optoelektronik GmbH Merzhauser Str. 134 D-79100 Freiburg Tel.: (0761)29644-44 Fax: (0761)29644-55/56	Product <b>ZFSM</b>	Date: <b>2017.01.24</b>	Page: <b>26 of 64</b>
	Advanced Information <b>Document-ID: UI-ZL-120005-2.0-2017-01-24</b>		Author: <b>TR</b>

<table border="1"> <tr> <td>WR-Device-ID</td> <td>CMD (0x84)</td> <td>Sub Address</td> <td>CRC-TGM</td> </tr> <tr> <td>RD-Device-ID</td> <td>System Status</td> <td>Op. Status</td> <td>CRC-TGM</td> </tr> </table> <p>(Status followed by CRC and trailing fill bytes when data can not be returned instantaneously)</p> <p>(The Sub Address is redundant for this command because it must be 0x00 to address the master module which maintains the system status)</p> <p><b>Module Status Byte Codes</b></p> <table border="1"> <tr> <td>0x00</td> <td>OP_STAT_SYSTEM_STARTUP</td> </tr> <tr> <td>0x01</td> <td>OP_STAT_STANDBY</td> </tr> <tr> <td>0x02</td> <td>OP_STAT_READY_OPERATION</td> </tr> <tr> <td>0x03</td> <td>OP_STAT_SERVICE</td> </tr> <tr> <td>0x04</td> <td>OP_STAT_FAILURE</td> </tr> <tr> <td>0x05</td> <td>OP_STAT_POWERDOWN</td> </tr> </table>	WR-Device-ID	CMD (0x84)	Sub Address	CRC-TGM	RD-Device-ID	System Status	Op. Status	CRC-TGM	0x00	OP_STAT_SYSTEM_STARTUP	0x01	OP_STAT_STANDBY	0x02	OP_STAT_READY_OPERATION	0x03	OP_STAT_SERVICE	0x04	OP_STAT_FAILURE	0x05	OP_STAT_POWERDOWN	
WR-Device-ID	CMD (0x84)	Sub Address	CRC-TGM																		
RD-Device-ID	System Status	Op. Status	CRC-TGM																		
0x00	OP_STAT_SYSTEM_STARTUP																				
0x01	OP_STAT_STANDBY																				
0x02	OP_STAT_READY_OPERATION																				
0x03	OP_STAT_SERVICE																				
0x04	OP_STAT_FAILURE																				
0x05	OP_STAT_POWERDOWN																				
<p><b>GET_MODE</b> - reads the hardware mode of the LDU (unsigned character).</p> <table border="1"> <tr> <td>WR-Device-ID</td> <td>CMD (0x14)</td> <td>Sub Address</td> <td>CRC-TGM</td> </tr> <tr> <td>RD-Device-ID</td> <td>System Status</td> <td>Mode-Byte</td> <td>CRC-TGM</td> </tr> </table> <p>(Status followed by CRC and trailing fill bytes when data can not be returned instantaneously)</p> <p><b>Bits of the mode Byte</b></p> <table border="1"> <tr> <td>Bit 0</td> <td>Enable on/off the digital modulation control input (1 == on)</td> </tr> <tr> <td>Bit 1</td> <td>Invert the digital modulation control input ( 1 == inverted)</td> </tr> <tr> <td>Bit 2</td> <td>Enable "System_Enable" control input ( 1 == enabled) This Bit cannot be modified in SFTY configurations</td> </tr> <tr> <td>Bit 3</td> <td>Enable on/off the analog modulation control input (1 == on)</td> </tr> </table>	WR-Device-ID	CMD (0x14)	Sub Address	CRC-TGM	RD-Device-ID	System Status	Mode-Byte	CRC-TGM	Bit 0	Enable on/off the digital modulation control input (1 == on)	Bit 1	Invert the digital modulation control input ( 1 == inverted)	Bit 2	Enable "System_Enable" control input ( 1 == enabled) This Bit cannot be modified in SFTY configurations	Bit 3	Enable on/off the analog modulation control input (1 == on)					
WR-Device-ID	CMD (0x14)	Sub Address	CRC-TGM																		
RD-Device-ID	System Status	Mode-Byte	CRC-TGM																		
Bit 0	Enable on/off the digital modulation control input (1 == on)																				
Bit 1	Invert the digital modulation control input ( 1 == inverted)																				
Bit 2	Enable "System_Enable" control input ( 1 == enabled) This Bit cannot be modified in SFTY configurations																				
Bit 3	Enable on/off the analog modulation control input (1 == on)																				
<p><b>GET_POWER_VALUE</b> - reads the current laser power as percentage (unsigned character – single byte) of nominal laser power</p> <table border="1"> <tr> <td>WR-Device-ID</td> <td>CMD (0x4E)</td> <td>Sub Address</td> <td>CRC-TGM</td> </tr> <tr> <td>RD-Device-ID</td> <td>System Status</td> <td>Power Value</td> <td>CRC-TGM</td> </tr> </table> <p>(Status followed by CRC and trailing fill bytes when data can not be returned instantaneously)</p> <p>This command returns the programmed laser power. This command does not advise if the laser is switched on or off. GET_LASER must be used therefore.</p>	WR-Device-ID	CMD (0x4E)	Sub Address	CRC-TGM	RD-Device-ID	System Status	Power Value	CRC-TGM													
WR-Device-ID	CMD (0x4E)	Sub Address	CRC-TGM																		
RD-Device-ID	System Status	Power Value	CRC-TGM																		

 Z-Laser Optoelektronik GmbH Merzhauser Str. 134 D-79100 Freiburg Tel.: (0761)29644-44 Fax: (0761)29644-55/56	Product <b>ZFSM</b>	Date: <b>2017.01.24</b>	Page: <b>27 of 64</b>
	Advanced Information <b>Document-ID: UI-ZL-120005-2.0-2017-01-24</b>		Author: <b>TR</b>

<p><b>GET_LD_TEMP</b> - reads the laser temperature as unsigned integer value (2 bytes) in °C/100</p> <table border="1"> <tr> <td>WR-Device-ID</td> <td>CMD (0x40)</td> <td>Sub Address</td> <td>CRC-TGM</td> </tr> <tr> <td>RD-Device-ID</td> <td>System Status</td> <td>Temp Hi-Byte</td> <td>Temp Lo-Byte</td> <td>CRC-TGM</td> </tr> </table> <p>(Status followed by CRC and trailing fill bytes when data can not be returned instantaneously)</p>	WR-Device-ID	CMD (0x40)	Sub Address	CRC-TGM	RD-Device-ID	System Status	Temp Hi-Byte	Temp Lo-Byte	CRC-TGM						
WR-Device-ID	CMD (0x40)	Sub Address	CRC-TGM												
RD-Device-ID	System Status	Temp Hi-Byte	Temp Lo-Byte	CRC-TGM											
<p><b>GET_LASER_CURRENT</b> - reads the laser current as unsigned integer value (2 bytes) in mA. Note: this command returns the total laser current (bias current plus operating current)</p> <table border="1"> <tr> <td>WR-Device-ID</td> <td>CMD (0x12)</td> <td>Sub Address</td> <td>CRC-TGM</td> </tr> <tr> <td>RD-Device-ID</td> <td>System Status</td> <td>Current Hi-Byte</td> <td>Temp Lo-Byte</td> <td>CRC-TGM</td> </tr> </table> <p>(Status followed by CRC and trailing fill bytes when data can not be returned instantaneously)</p>	WR-Device-ID	CMD (0x12)	Sub Address	CRC-TGM	RD-Device-ID	System Status	Current Hi-Byte	Temp Lo-Byte	CRC-TGM						
WR-Device-ID	CMD (0x12)	Sub Address	CRC-TGM												
RD-Device-ID	System Status	Current Hi-Byte	Temp Lo-Byte	CRC-TGM											
<p><b>GET_CALIBRATED_LASER</b> - reads the calibrated laser power in 0.01 mW steps as unsigned character and wavelength in nm as unsigned integer (2 byte). This command returns the 100% nominal laser power at the end of the output fiber as well as its wavelength.</p> <table border="1"> <tr> <td>WR-Device-ID</td> <td>CMD (0x7E)</td> <td>Sub Address</td> <td>CRC-TGM</td> </tr> <tr> <td>RD-Device-ID</td> <td>System Status</td> <td>Power Value Hi</td> <td>Power Value Lo</td> <td>Wavelength-Hi</td> </tr> <tr> <td></td> <td></td> <td>Wavelength-Lo</td> <td>CRC-TGM</td> <td></td> </tr> </table> <p>(Status followed by CRC and trailing fill bytes when data can not be returned instantaneously)</p>	WR-Device-ID	CMD (0x7E)	Sub Address	CRC-TGM	RD-Device-ID	System Status	Power Value Hi	Power Value Lo	Wavelength-Hi			Wavelength-Lo	CRC-TGM		
WR-Device-ID	CMD (0x7E)	Sub Address	CRC-TGM												
RD-Device-ID	System Status	Power Value Hi	Power Value Lo	Wavelength-Hi											
		Wavelength-Lo	CRC-TGM												
<p><b>GET_LASER</b> - reads the setting of the Laser-ON-OFF status (unsigned character: 0 = laser off, 1 = laser on).</p> <table border="1"> <tr> <td>WR-Device-ID</td> <td>CMD (0x44)</td> <td>Sub Address</td> <td>CRC-TGM</td> </tr> <tr> <td>RD-Device-ID</td> <td>System Status</td> <td>Setting</td> <td>CRC-TGM</td> </tr> </table> <p>(Status followed by CRC and trailing fill bytes when data can not be returned instantaneously)</p>	WR-Device-ID	CMD (0x44)	Sub Address	CRC-TGM	RD-Device-ID	System Status	Setting	CRC-TGM							
WR-Device-ID	CMD (0x44)	Sub Address	CRC-TGM												
RD-Device-ID	System Status	Setting	CRC-TGM												
<p><b>GET_LD_LIFETIME</b> - reads the laser diodes accumulated operating hours as unsigned integer value (2 bytes) in hours</p> <table border="1"> <tr> <td>WR-Device-ID</td> <td>CMD (0x22)</td> <td>Sub Address</td> <td>CRC-TGM</td> </tr> <tr> <td>RD-Device-ID</td> <td>System Status</td> <td>Time Hi-Byte</td> <td>Time Lo-Byte</td> <td>CRC-TGM</td> </tr> </table> <p>(Status followed by CRC and trailing fill bytes when data can not be returned instantaneously)</p>	WR-Device-ID	CMD (0x22)	Sub Address	CRC-TGM	RD-Device-ID	System Status	Time Hi-Byte	Time Lo-Byte	CRC-TGM						
WR-Device-ID	CMD (0x22)	Sub Address	CRC-TGM												
RD-Device-ID	System Status	Time Hi-Byte	Time Lo-Byte	CRC-TGM											
<p><b>GET_MODULE_ONTIME</b> - reads the laser modules operating time after the last power on as unsigned integer value (2 bytes) in hours</p>															

 Z-Laser Optoelektronik GmbH Merzhauser Str. 134 D-79100 Freiburg Tel.: (0761)29644-44 Fax: (0761)29644-55/56	Product <b>ZFSM</b>	Date: <b>2017.01.24</b>	Page: <b>28 of 64</b>
	Advanced Information <b>Document-ID: UI-ZL-120005-2.0-2017-01-24</b>		Author: <b>TR</b>

<table border="1"> <tr> <td>WR-Device-ID</td> <td>CMD (0x7A)</td> <td>Sub Address</td> <td>CRC-TGM</td> </tr> <tr> <td>RD-Device-ID</td> <td>System Status</td> <td>Time Hi-Byte</td> <td>Time Lo-Byte</td> <td>CRC-TGM</td> </tr> </table> <p>(Status followed by CRC and trailing fill bytes when data can not be returned instantaneously)</p>	WR-Device-ID	CMD (0x7A)	Sub Address	CRC-TGM	RD-Device-ID	System Status	Time Hi-Byte	Time Lo-Byte	CRC-TGM		
WR-Device-ID	CMD (0x7A)	Sub Address	CRC-TGM								
RD-Device-ID	System Status	Time Hi-Byte	Time Lo-Byte	CRC-TGM							
<p><b>GET_MODULE_TOTAL_ONTIME</b> - reads the laser modules total operating time after the first power-on as unsigned integer value (2 bytes) in hours</p> <table border="1"> <tr> <td>WR-Device-ID</td> <td>CMD (0x78)</td> <td>Sub Address</td> <td>CRC-TGM</td> </tr> <tr> <td>RD-Device-ID</td> <td>System Status</td> <td>Time Hi-Byte</td> <td>Time Lo-Byte</td> <td>CRC-TGM</td> </tr> </table> <p>(Status followed by CRC and trailing fill bytes when data can not be returned instantaneously)</p>	WR-Device-ID	CMD (0x78)	Sub Address	CRC-TGM	RD-Device-ID	System Status	Time Hi-Byte	Time Lo-Byte	CRC-TGM		
WR-Device-ID	CMD (0x78)	Sub Address	CRC-TGM								
RD-Device-ID	System Status	Time Hi-Byte	Time Lo-Byte	CRC-TGM							
<p><b>GET_FW_VERSION</b> - reads the firmware version as unsigned integer value (3 bytes)</p> <table border="1"> <tr> <td>WR-Device-ID</td> <td>CMD (0xF0)</td> <td>Sub Address</td> <td>CRC-TGM</td> </tr> <tr> <td>RD-Device-ID</td> <td>System Status</td> <td>Major Version</td> <td>Middle Version</td> <td>Minor Version</td> <td>CRC-TGM</td> </tr> </table> <p>(Status followed by CRC and trailing fill bytes when data can not be returned instantaneously)</p>	WR-Device-ID	CMD (0xF0)	Sub Address	CRC-TGM	RD-Device-ID	System Status	Major Version	Middle Version	Minor Version	CRC-TGM	
WR-Device-ID	CMD (0xF0)	Sub Address	CRC-TGM								
RD-Device-ID	System Status	Major Version	Middle Version	Minor Version	CRC-TGM						
<p><b>GET_HW_VERSION</b> -reads the hardware version as unsigned integer value (3 bytes)</p> <table border="1"> <tr> <td>WR-Device-ID</td> <td>CMD (0x6E)</td> <td>Sub Address</td> <td>CRC-TGM</td> </tr> <tr> <td>RD-Device-ID</td> <td>System Status</td> <td>Major Version</td> <td>Middle Version</td> <td>Minor Version</td> <td>CRC-TGM</td> </tr> </table> <p>(Status followed by CRC and trailing fill bytes when data can not be returned instantaneously)</p>	WR-Device-ID	CMD (0x6E)	Sub Address	CRC-TGM	RD-Device-ID	System Status	Major Version	Middle Version	Minor Version	CRC-TGM	
WR-Device-ID	CMD (0x6E)	Sub Address	CRC-TGM								
RD-Device-ID	System Status	Major Version	Middle Version	Minor Version	CRC-TGM						
<p><b>GET_SERIAL_NO</b> - get the serial number by 10 ASCII bytes (0x30...0x39) – can only be set in the authorized service status</p> <table border="1"> <tr> <td>WR-Device-ID</td> <td>CMD (0xF2)</td> <td>Sub Address</td> <td>CRC-TGM</td> </tr> <tr> <td>RD-Device-ID</td> <td>System Status</td> <td>10 data bytes</td> <td>CRC-TGM</td> </tr> </table> <p>(Status followed by CRC and trailing fill bytes when data can not be returned instantaneously)</p>	WR-Device-ID	CMD (0xF2)	Sub Address	CRC-TGM	RD-Device-ID	System Status	10 data bytes	CRC-TGM			
WR-Device-ID	CMD (0xF2)	Sub Address	CRC-TGM								
RD-Device-ID	System Status	10 data bytes	CRC-TGM								

 Z-Laser Optoelektronik GmbH Merzhauser Str. 134 D-79100 Freiburg Tel.: (0761)29644-44 Fax: (0761)29644-55/56	Product <b>ZFSM</b>	Date: <b>2017.01.24</b>	Page: <b>29 of 64</b>
	Advanced Information <b>Document-ID: UI-ZL-120005-2.0-2017-01-24</b>		Author: <b>TR</b>

#### 4.3.4 List of write telegrams:

Feature		Reference
<b>SET_MODE</b> Set various hardware modes of the LDU's		
WR-Device-ID	CMD (0x13)	Sub Address
		Mode-Byte
		CRC-TGM
RD-Device-ID	System Status	CRC-TGM
		(RD transmission can be repeated)
With SET_SYSTEM_PWDWN the programmed settings are written to a non-volatile memory and stay valid after the next power cycle		
Bits of the mode Byte:		
Bit 0	Enable the digital modulation control input (1 == on) Default: 1 Attention: if the digital modulation is disabled, the laser will start up after a power cycle according to the setting of Bit 1: Bit 1 = 0 → the module will start up with laser OFF, can only be switched on by a SET_LASER command Bit 1 = 1 → the module will start up with laser ON (unless a power value less than 10% has been programmed)	
Bit 1	Invert the digital modulation control input ( 1 == inverted) Default: 0	
Bit 2	Enable "System_Enable" control input ( 1 == enabled) This Bit cannot be modified in SFTY configurations Default in SFTY configuration: 1 Default in NON-SFTY configuration: 0	
Bit 3	Enable the analogue modulation control input (1 == on) Default: 1 → laser power is always 100% when switched ON	
Bit 4	Over/Undertemp_Shutdown (1 = on) Default: 1	
Bit 5	Extrapolation (1 = on), for internal use only, should not be changed Default: 1	
Bit 6	Pattern_Generator (1 = on), when a "Pulse Generator" AddOn Module is attached this mode bit determines if the modulation is controlled by the AddOn board (1) or via X2 (0) Default: 0	
Bit 7	Biascurrent_Always_on (1 = on), when active the bias current of the laser diode remains constantly on even if the laser is switched off by the digital modulation control. Thus the rise and fall time of the modulation can be significantly faster. However the light out of the fiber might not be 100% off but remains at a very dim level. Default: 0	
<b>SYSTEM_CRC_OFF (telegram not enabled for SFTY configurations)</b> disable CRC checks for the entire system (unsigned character: 0 = CRC checks on, 1 = CRC checks off) – default is to always check CRC's		
This command is only meant to support the user during lab setup and evaluation work. Some terminal programs cannot calculate CRC data dynamically. CRC checks are essential for system integrity and functional safety requirements.		

 Z-Laser Optoelektronik GmbH Merzhauser Str. 134 D-79100 Freiburg Tel.: (0761)29644-44 Fax: (0761)29644-55/56	Product <b>ZFSM</b>	Date: <b>2017.01.24</b>	Page: <b>30 of 64</b>
	Advanced Information <b>Document-ID: UI-ZL-120005-2.0-2017-01-24</b>		Author: <b>TR</b>

<table border="1"> <tr> <td>WR-Device-ID</td> <td>CMD (0x47)</td> <td>Sub Address</td> <td>Parameter</td> <td>CRC-TGM</td> </tr> </table> <table border="1"> <tr> <td>RD-Device-ID</td> <td>System Status</td> <td>CRC-TGM</td> <td colspan="2">(RD transmission can be repeated)</td> </tr> </table> <p>Example for the entire system: Write (WR-device-ID, 0x47, 0xFF, 0x01, 0x46) Read (RD-device-ID, 0x00, 0x35)</p> <p>This setting cannot be stored permanently; it will turn back to the default value after the next power cycle.</p>	WR-Device-ID	CMD (0x47)	Sub Address	Parameter	CRC-TGM	RD-Device-ID	System Status	CRC-TGM	(RD transmission can be repeated)										
WR-Device-ID	CMD (0x47)	Sub Address	Parameter	CRC-TGM															
RD-Device-ID	System Status	CRC-TGM	(RD transmission can be repeated)																
<p><b>SET_POWER_VALUE</b> - programs the laser current statically (DAC setting) as percentage (unsigned character – single byte) of nominal laser power.</p> <table border="1"> <tr> <td>WR-Device-ID</td> <td>CMD (0x4F)</td> <td>Sub Address</td> <td>Power Value</td> <td>CRC-PARM</td> <td>CRC-ADR</td> </tr> <tr> <td>CRC-TGM</td> <td colspan="5"></td> </tr> </table> <table border="1"> <tr> <td>RD-Device-ID</td> <td>System Status</td> <td>CRC-TGM</td> <td colspan="3">(RD transmission can be repeated)</td> </tr> </table> <p>With SET_SYSTEM_PWDWN the programmed setting is written to non-volatile memory and stays valid after next power cycle.</p> <p><b>Attention: reducing the laser intensity via SET_POWER_VALUE command does not change the laser classification</b></p>	WR-Device-ID	CMD (0x4F)	Sub Address	Power Value	CRC-PARM	CRC-ADR	CRC-TGM						RD-Device-ID	System Status	CRC-TGM	(RD transmission can be repeated)			
WR-Device-ID	CMD (0x4F)	Sub Address	Power Value	CRC-PARM	CRC-ADR														
CRC-TGM																			
RD-Device-ID	System Status	CRC-TGM	(RD transmission can be repeated)																
<p><b>SET_LASER</b> - Switch ON or OFF the laser (unsigned character: 0 = laser off, 1 = laser on).</p> <table border="1"> <tr> <td>WR-Device-ID</td> <td>CMD (0x45)</td> <td>Sub Address</td> <td>Parameter</td> <td>CRC-PARM</td> <td>CRC-ADR</td> </tr> <tr> <td>CRC-TGM</td> <td colspan="5"></td> </tr> </table> <table border="1"> <tr> <td>RD-Device-ID</td> <td>System Status</td> <td>CRC-TGM</td> <td colspan="3">(RD transmission can be repeated)</td> </tr> </table> <p>Example for single LDU: Write (WR-Device-ID, 0x45, 0x00, 0x01, 0x5E, 0xCF, 0x79) Read (RD-Device-ID, 0x00, 0x35)</p> <p>Example for the entire system: Write (WR-Device-ID, 0x45, 0xFF, 0x01, 0x5E, 0xCF, 0x92) Read (RD-Device-ID, 0x00, 0x35)</p> <p>This setting cannot be stored permanently</p>	WR-Device-ID	CMD (0x45)	Sub Address	Parameter	CRC-PARM	CRC-ADR	CRC-TGM						RD-Device-ID	System Status	CRC-TGM	(RD transmission can be repeated)			
WR-Device-ID	CMD (0x45)	Sub Address	Parameter	CRC-PARM	CRC-ADR														
CRC-TGM																			
RD-Device-ID	System Status	CRC-TGM	(RD transmission can be repeated)																
<p><b>SET_STARTUP_DEFAULT</b> - sets laser power of an LDU to the factory calibrated value</p>																			

 Z-Laser Optoelektronik GmbH Merzhauser Str. 134 D-79100 Freiburg Tel.: (0761)29644-44 Fax: (0761)29644-55/56	Product <b>ZFSM</b>	Date: <b>2017.01.24</b>	Page: <b>31 of 64</b>
	Advanced Information <b>Document-ID: UI-ZL-120005-2.0-2017-01-24</b>		Author: <b>TR</b>

<table border="1"> <tr> <td>WR-Device-ID</td> <td>CMD (0xF7)</td> <td>Sub Address</td> <td>CRC-ADR</td> <td>CRC-TGM</td> </tr> </table> <table border="1"> <tr> <td>RD-Device-ID</td> <td>System Status</td> <td>CRC-TGM</td> <td>(RD transmission can be repeated)</td> </tr> </table> <p>Example for a single LDU:  Write (WR-Device-ID,0xF7, 0x00, 0xCF, 0xAE)  Read (RD-Device-ID, 0x00, 0x35)</p> <p>Example for the entire system:  Write (WR-Device-ID,0xF7, 0xFF, 0x00, 0xA4)  Read (RD-Device-ID, 0x00, 0x35)</p>	WR-Device-ID	CMD (0xF7)	Sub Address	CRC-ADR	CRC-TGM	RD-Device-ID	System Status	CRC-TGM	(RD transmission can be repeated)		
WR-Device-ID	CMD (0xF7)	Sub Address	CRC-ADR	CRC-TGM							
RD-Device-ID	System Status	CRC-TGM	(RD transmission can be repeated)								
<p><b>SET_PASSWD</b> - sets system password before entering system READY STATUS and thus to enable critical procedures (laser operation). For the prototypes the password is 0x00CA</p> <table border="1"> <tr> <td>WR-Device-ID</td> <td>CMD (0xF5)</td> <td>Sub Address</td> <td>PASSWD-hi</td> <td>PASSWD-lo</td> <td>CRC-TGM</td> </tr> </table> <table border="1"> <tr> <td>RD-Device-ID</td> <td>System Status</td> <td>CRC-TGM</td> <td>(RD transmission can be repeated)</td> </tr> </table> <p>Example for a single LDU:  Write (WR-Device-ID,0xF5, 0x00, 0x00, 0xCA, 0xAF)  Read (RD-Device-ID, 0x00, 0x35)</p> <p>Example for the entire system:  Write (WR-Device-ID,0xF5, 0xFF, 0x00, 0xCA, 0x7D)  Read (RD-Device-ID, 0x00, 0x35)</p> <p>This setting cannot be stored permanently</p>	WR-Device-ID	CMD (0xF5)	Sub Address	PASSWD-hi	PASSWD-lo	CRC-TGM	RD-Device-ID	System Status	CRC-TGM	(RD transmission can be repeated)	
WR-Device-ID	CMD (0xF5)	Sub Address	PASSWD-hi	PASSWD-lo	CRC-TGM						
RD-Device-ID	System Status	CRC-TGM	(RD transmission can be repeated)								
<p><b>SET_SYSTEM_PWDWN</b> - Set the system into the POWER_DOWN Status. Shuts off all critical functions and saves critical settings</p> <table border="1"> <tr> <td>WR-Device-ID</td> <td>CMD (0x03)</td> <td>Sub Address</td> <td>CRC-TGM</td> </tr> </table> <table border="1"> <tr> <td>RD-Device-ID</td> <td>System Status</td> <td>CRC-TGM</td> <td>(RD transmission can be repeated)</td> </tr> </table> <p>Example for a single LDU:  Write (WR-Device-ID,0x03, 0x00, 0xD4)  Read (RD-Device-ID, 0x00, 0x35)</p> <p>Example for the entire system:  Write (WR-Device-ID,0x03, 0xFF, 0xE1)  Read (RD-Device-ID, 0x00, 0x35)</p>	WR-Device-ID	CMD (0x03)	Sub Address	CRC-TGM	RD-Device-ID	System Status	CRC-TGM	(RD transmission can be repeated)			
WR-Device-ID	CMD (0x03)	Sub Address	CRC-TGM								
RD-Device-ID	System Status	CRC-TGM	(RD transmission can be repeated)								

 Z-Laser Optoelektronik GmbH Merzhauser Str. 134 D-79100 Freiburg Tel.: (0761)29644-44 Fax: (0761)29644-55/56	Product <b>ZFSM</b>	Date: <b>2017.01.24</b>	Page: <b>32 of 64</b>
	Advanced Information <b>Document-ID: UI-ZL-120005-2.0-2017-01-24</b>		Author: <b>TR</b>

### 4.3.5 Communication Procedures

After every write telegram (SET\_\*) it is necessary to wait until the command has been completely executed. In the case of a multi module configuration, this might take a longer time to pass the information down to sub modules. No write telegram will be processed until the execution of a previous one has been completed.

The regular read transmission of a write telegram returns the system status. If the status indicates a “busy” (Bit 0 = 1) then the write telegram has not yet been completed. The TWI host can then repeat this read transmission multiple times until the “busy” flag indicates the completion (Bit 0 = 0).

All subsequent TWI telegrams are discarded before the busy bit is reset. The returned status indicates a discarded telegram with a “NACK” flag (Bit 3 = 1). Upon receiving a “NACK” status of a telegram, the TWI host should repeat the complete first write telegram to confirm the successful completion.

Some read telegrams cannot provide instantaneous return data. The read transmission indicates this with a “busy” flag (Bit 0 = 1) in the system status. In this case, no data payload is returned, instead the CRC-TGM is appended as well as the respective number of fill bytes.

The TWI host can repeat the read transmission multiple times until the busy flag is reset (Bit 0 = 0) and valid data are returned. A premature TWI telegram is discarded and its read transmission returns a “NACK” flag in the system status. To receive the previously requested data, the TWI host must repeat the completed first read telegram.

In case of telegram failures, the user must query the module status of the addressed LDU module and react accordingly.

When a warning (X1.4) occurs, the user must query all sub module individually for the reason of the warning and reset the warning condition in the respective sub module.

### 4.3.6 Communication Status

A telegram can fail in the transmission or in the interpretation phase. Whenever this occurs a warning is indicated at X1.4 (active low) and the command is not executed. The user must query the system and reset the failure condition.

The system is not shut down as a consequence of a telegram failure.

## 4.4 System Status

The MMCU software steers the functions of the entire system and presents them to the user. For a clean use model, the systems behavior is described by a few major operation modes that can be read out with GET\_OPERATION\_STATUS telegrams.

<b>System Startup Status</b>	
After powering up, the system housekeeping and self-test tasks are performed. During this period, the system is not ready for further user interaction.	

 Z-Laser Optoelektronik GmbH Merzhauser Str. 134 D-79100 Freiburg Tel.: (0761)29644-44 Fax: (0761)29644-55/56	Product <b>ZFSM</b>	Date: <b>2017.01.24</b>	Page: <b>33 of 64</b>
	Advanced Information <b>Document-ID: UI-ZL-120005-2.0-2017-01-24</b>		Author: <b>TR</b>

<p>Laser Class: --</p> <p>System Control:</p> <ul style="list-style-type: none"> <li>• System Enable (X1.7) = low (or open) → “inactive”</li> <li>• System Shutdown (X1.1) = high (i.e open) → “inactive”</li> </ul> <p>LED-Indication:</p> <ul style="list-style-type: none"> <li>• green LED blinking fast</li> </ul> <p>Activities:</p> <ul style="list-style-type: none"> <li>• Powering up the system until all supply voltages are stable, release reset states</li> <li>• Invalidate system password setting (reset user setting)</li> <li>• Warm-up of the laser diodes (when a TEC enhancement is available)</li> <li>• Waiting for a environmental target value, e.g. temperature</li> <li>• Self-test of all system main functions</li> <li>• Self-test of all safety and surveillance functions</li> <li>• Initialize the system with calibrated settings or if available with saved settings from the last session (e.g. after a failure occurrence)</li> <li>• Restart the on-time counter</li> </ul> <p>Inactivity's:</p> <ul style="list-style-type: none"> <li>• Communication Interfaces are inactive</li> <li>• Laser Light cannot be emitted</li> </ul> <p>Signaling:</p> <ul style="list-style-type: none"> <li>• System Shutdown (X1.1) can toggle due to self-test procedures</li> <li>• System Enable (X1.7) can toggle due to self-test procedures</li> <li>• Early Warning (X1.4) is low (active) Attention: For a very short time, this signal might not yet be stable</li> </ul> <p>Transition to Failure Status:</p> <ul style="list-style-type: none"> <li>• Upon encountering a nonconformity (Error, Attention: no correct action might be possible in this case)</li> <li>• Upon System Shutdown (X1.1) = low (i.e open) → “active”</li> <li>• Upon reaching a time limit</li> </ul> <p>Transition to Standby Status</p> <ul style="list-style-type: none"> <li>• Upon completion of all activities AND System is configured as SFTY-system</li> </ul> <p>Transition to Ready Status</p> <ul style="list-style-type: none"> <li>• Upon completion of all activities AND System is configured as non-SFTY-system AND System is in a calibrated mode AND No system nonconformity is pending (warning, error)</li> </ul> <p>Transition to System Startup Status:</p>	
--	--

 Z-Laser Optoelektronik GmbH Merzhauser Str. 134 D-79100 Freiburg Tel.: (0761)29644-44 Fax: (0761)29644-55/56	Product <b>ZFSM</b>	Date: <b>2017.01.24</b>	Page: <b>34 of 64</b>
	Advanced Information <b>Document-ID: UI-ZL-120005-2.0-2017-01-24</b>		Author: <b>TR</b>

<ul style="list-style-type: none"> <li>Upon power cycling the LDU, i.e. switching it OFF and ON again</li> </ul> Transition to Power Down Status: <ul style="list-style-type: none"> <li>Upon powering down the system</li> </ul>	
<b>Standby Status</b>	
Laser Class: --  System Control: <ul style="list-style-type: none"> <li>System Enable (X1.7) = low (or open) → “inactive”</li> <li>System Shutdown (X1.1) = high (i.e open) → “inactive”</li> </ul> LED-Indication: <ul style="list-style-type: none"> <li>green LED blinking slowly (indicates active communication channels)</li> </ul> Activities: <ul style="list-style-type: none"> <li>Permanent cross checks of the MCU's</li> <li>Listens to TWI telegrams</li> </ul> Inactivity's: <ul style="list-style-type: none"> <li>Laser Light cannot be emitted</li> <li>Unaccepted TWI commands: SET_LASER (and others)</li> </ul> Signaling: <ul style="list-style-type: none"> <li>System Shutdown (X1.1) is high (inactive)</li> <li>Early Warning (X1.4) indicates warnings upon occurrence</li> </ul> Transition to Ready Status: <ul style="list-style-type: none"> <li>System Enable (X1.7) = high (active)</li> <li>AND System is configured as SFTY system</li> <li>AND System password has been set and validated</li> <li>AND System is in a calibrated mode</li> <li>AND No system nonconformity is pending (warning, error)</li> </ul> Transition to Failure Status: <ul style="list-style-type: none"> <li>Upon encountering a nonconformity (Error)</li> <li>Upon System Shutdown (X1.1) = low (i.e open) → “active”</li> </ul> Transition to System Startup Status: <ul style="list-style-type: none"> <li>Upon power cycling the LDU, i.e. switching it OFF and ON again</li> </ul> Transition to Power Down Status: <ul style="list-style-type: none"> <li>Upon receiving the SET_SYSTEM_PWDWN command via TWI</li> </ul>	
<b>Ready Status</b>	
Laser Class: --	

 Z-Laser Optoelektronik GmbH Merzhauser Str. 134 D-79100 Freiburg Tel.: (0761)29644-44 Fax: (0761)29644-55/56	Product <b>ZFSM</b>	Date: <b>2017.01.24</b>	Page: <b>35 of 64</b>
	Advanced Information <b>Document-ID: UI-ZL-120005-2.0-2017-01-24</b>		Author: <b>TR</b>

<p><b>System Control:</b></p> <ul style="list-style-type: none"> <li>• System Enable (X1.7) = high (only SFTY) → “active”</li> <li>• System Shutdown (X1.1) = high (i.e. open) → “inactive”</li> </ul> <p><b>LED-Indication:</b></p> <ul style="list-style-type: none"> <li>• green LED permanently ON</li> </ul> <p><b>Activities:</b></p> <ul style="list-style-type: none"> <li>• Permanent cross checks of the MCU's</li> <li>• Listens to TWI telegrams</li> </ul> <p><b>Inactivity's:</b></p> <ul style="list-style-type: none"> <li>• Unaccepted TWI commands: SET_LASER (and others)</li> </ul> <p><b>Signaling:</b></p> <ul style="list-style-type: none"> <li>• System Shutdown (X1.1) is high (inactive)</li> <li>• Early Warning (X1.4) indicates warnings upon occurrence</li> </ul> <p><b>Transition to Operation Status:</b></p> <ul style="list-style-type: none"> <li>• Upon Digital modulation = high (active) AND Laser light emission is switched ON via TWI telegram AND System is configured as SFTY system</li> <li>• Upon Digital modulation = high (active) AND System is configured as non-SFTY system</li> </ul> <p><b>Transition to Standby Status:</b></p> <ul style="list-style-type: none"> <li>• Upon System Enable (X1.7) = low (inactive) AND System is configured as SFTY-system</li> </ul> <p><b>Transition to Failure Status:</b></p> <ul style="list-style-type: none"> <li>• Upon encountering a nonconformity (Error)</li> <li>• Upon System Shutdown (X1.1) = low (i.e open) → “active”</li> </ul> <p><b>Transition to System Startup Status:</b></p> <ul style="list-style-type: none"> <li>• Upon power cycling the LDU, i.e. switching it OFF and ON again</li> </ul> <p><b>Transition to Power Down Status:</b></p> <ul style="list-style-type: none"> <li>• Upon receiving the SET_SYSTEM_PWDWN command via TWI</li> </ul>	
<b>Operation Status</b>	
<p>Laser Class: 3B</p> <p><b>System Control:</b></p> <ul style="list-style-type: none"> <li>• System Enable (X1.7) = high (only SFTY) → “active”</li> <li>• System Shutdown (X1.1) = high (i.e open) → “inactive”</li> </ul> <p><b>LED-Indication:</b></p>	

 Z-Laser Optoelektronik GmbH Merzhauser Str. 134 D-79100 Freiburg Tel.: (0761)29644-44 Fax: (0761)29644-55/56	Product <b>ZFSM</b>	Date: <b>2017.01.24</b>	Page: <b>36 of 64</b>
	Advanced Information <b>Document-ID: UI-ZL-120005-2.0-2017-01-24</b>		Author: <b>TR</b>

<ul style="list-style-type: none"> <li>• green LED permanently ON</li> <li>• yellow LED ON when laser beam is ON</li> </ul> <p>Activities:</p> <ul style="list-style-type: none"> <li>• Laser starts emitting light upon Digital Modulation input (X2.2) = high</li> <li>• Measures ON time of the laser source and calculates remaining life time</li> <li>• Permanent cross checks of the MCU's</li> <li>• Listens to TWI telegrams</li> </ul> <p>Inactivity's:</p> <ul style="list-style-type: none"> <li>• Unaccepted TWI commands: SET_LASER (and others)</li> </ul> <p>Signaling:</p> <ul style="list-style-type: none"> <li>• System Shutdown (X1.1) is high (inactive)</li> <li>• Early Warning (X1.4) indicates warnings upon occurrence</li> </ul> <p>Transition to Ready Status:</p> <ul style="list-style-type: none"> <li>• Upon Digital modulation = low (inactive)</li> <li>• Upon Switching off the laser light emission via TWI telegram</li> </ul> <p>Transition to Standby Status:</p> <ul style="list-style-type: none"> <li>• Upon System Enable (X1.7) = low (inactive) AND System is configured as SFTY-system</li> </ul> <p>Transition to Failure Status:</p> <ul style="list-style-type: none"> <li>• Upon encountering a nonconformity (Error)</li> <li>• Upon System Shutdown (X1.1) = low (i.e open) → "active"</li> </ul> <p>Transition to System Startup Status:</p> <ul style="list-style-type: none"> <li>• Upon power cycling the LDU, i.e. switching it OFF and ON again.</li> </ul> <p>Transition to Power Down Status:</p> <ul style="list-style-type: none"> <li>• Upon receiving the SET_SYSTEM_PWDWN command via TWI</li> </ul>	
<b>Failure Status</b>	
<p>System encountered a system Error. The user must actively query then and power cycle the system. The last system parameters are saved and resumed in the next run.</p> <p>Laser Class: --</p> <p>System Control:</p> <ul style="list-style-type: none"> <li>• System Shutdown (X1.1) = low → "active"</li> </ul> <p>LED-Indication:</p> <ul style="list-style-type: none"> <li>• green LED blinking (failure indication by special blink-code)</li> <li>• red LED permanently ON</li> </ul>	

 Z-Laser Optoelektronik GmbH Merzhauser Str. 134 D-79100 Freiburg Tel.: (0761)29644-44 Fax: (0761)29644-55/56	Product <b>ZFSM</b>	Date: <b>2017.01.24</b>	Page: <b>37 of 64</b>
	Advanced Information <b>Document-ID: UI-ZL-120005-2.0-2017-01-24</b>		Author: <b>TR</b>

<p><b>Activities:</b></p> <ul style="list-style-type: none"> <li>• Listens to TWI telegrams</li> <li>• Invalidate system password setting (reset user setting)</li> <li>• Disable laser supply and close LCByp</li> <li>• Program current DAC's to 0x000</li> </ul> <p><b>Inactivity's:</b></p> <ul style="list-style-type: none"> <li>• Laser cannot emit light</li> <li>• Unaccepted TWI commands: SET_LASER (and others)</li> </ul> <p><b>Transition to System Startup Status:</b></p> <ul style="list-style-type: none"> <li>• Upon power cycling the LDU, i.e. switching it OFF and ON again.</li> <li>• Upon querying the failure status AND resetting it via TWI protocol</li> </ul> <p><b>Transition to Power Down Status:</b></p> <ul style="list-style-type: none"> <li>• Upon receiving the SET_SYSTEM_PWDWN command via TWI</li> </ul>	
<b>Power Down Status</b>	
Controlled procedures before the power supply can safely be switched off.	
LED-Indication: Red, Green, Yellow LED blinking synchronously	
<p><b>Activities:</b></p> <ul style="list-style-type: none"> <li>• Critical parameters are saved to a non-volatile memory, e.g. accumulated operating time of the laser source</li> <li>• Switch off the laser</li> <li>• Disable laser supply and close LCByp</li> <li>• program current DAC's to 0x000</li> </ul> <p><b>Inactivity's:</b></p> <ul style="list-style-type: none"> <li>• Laser cannot emit light</li> <li>• Communication Interfaces are inactive</li> </ul> <p><b>Transition to System Startup Status:</b></p> <ul style="list-style-type: none"> <li>• Upon power cycling the LDU, i.e. switching it OFF and ON again.</li> </ul>	

## 4.5 How to control the laser

The driver electronics of the "ZFSM" fiber laser module has a digital control interface; it can statically be controlled via TWI (I2C telegrams)

**Attention: reducing the laser intensity via TWI telegrams does not change the laser classification**

 Z-Laser Optoelektronik GmbH Merzhauser Str. 134 D-79100 Freiburg Tel.: (0761)29644-44 Fax: (0761)29644-55/56	Product <b>ZFSM</b>	Date: <b>2017.01.24</b>	Page: <b>38 of 64</b>
	Advanced Information <b>Document-ID: UI-ZL-120005-2.0-2017-01-24</b>		Author: <b>TR</b>

#### 4.5.1 Static laser output power via I2C

The laser output power of the “ZFSM” module can be controlled statically via I2C telegrams. The user has to take care in understanding how the laser power is controlled in principle.

The laser power cannot be adjusted directly since there is no calibrated measurement implemented for the “laser power out of the fiber”. Instead the laser power is controlled by adjusting the laser current. Keeping the laser current under control is the most reliable way to prevent mode hopping and to provide low noise in the laser light.

The calibration of the output power of the entire laser module is done during a multi-dimensional calibration procedure in the manufacturing process. The maximum laser power is referred to as 100%. The laser control system preserves this nominal power throughout the entire lifetime and the entire specified temperature range. The user can set the output power for each colour individually linearly between ~10% and 100%. The target percentage is set via a TWI telegram (see chapter 4.3.4) or via the analogue control input X2.4. The control system preserves the user set power value over the temperature range and lifetime.

Although all settings are written to a non-volatile memory, the user should close a laser operation by powering down the system via TWI telegrams rather than shutting down the supply voltage. This ensures that all settings are recovered in the next power cycle.

#### 4.5.2 Failure Output – System Shutdown

Upon any severe system integrity violation, the “ZFSM” laser module is shut down. Pin X1.1 is an active low signal that is internally operated by an open-drain switch in every sub module. The host system can shut down the module as well or just use the pin as indicator that a severe internal error has occurred.

To determine what error happened and in which sub module, the user must query all sub modules via TWI telegrams. For error codes please refer to the GET\_MODULE\_STATUS command in chapter 4.3.3

#### 4.5.3 Warning Output

Less severe incidents are indicated by the “Early Warning” signal at Pin X1.4. This is an active-low signal as well and is operated by all sub modules via an open-drain switch. For warning code please refer as well to the GET\_MODULE\_STATUS command in chapter 4.3.3

### 4.6 LED status indication

Note: the LED’s are placed on the electronic PCB of the LDU. The LED’s are made visible in the housing equipped version of the Z-Fiber laser module. In custom specific configurations the LED’s might not be visible.

Behavior	Meaning	Reference
Green LED blinking fast	System Startup Status (communication channels are inactive)	
Green LED blinking slowly	Standby Status (communication channels are active)	

 Z-Laser Optoelektronik GmbH Merzhauser Str. 134 D-79100 Freiburg Tel.: (0761)29644-44 Fax: (0761)29644-55/56	Product <b>ZFSM</b>	Date: <b>2017.01.24</b>	Page: <b>39 of 64</b>
	Advanced Information <b>Document-ID: UI-ZL-120005-2.0-2017-01-24</b>		Author: <b>TR</b>

Green LED permanently ON		Ready Status (communication channels are active)	
Green LED permanently ON, Yellow LED ON (when laser light is ON)		Operation Status – Laser ON (communication channels are active)	
Green and red LED blinking alternately Yellow LED ON (when laser light is ON)		Service Status (communication channels are active)	
Red LED permanently ON, Green LED giving blink code		Warning Status, green blink code indicates Warning condition (communication channels are active)	
Red LED permanently ON	Green LED blinks 12 times	Over 24 Hours On-Time	
	Green LED blinks 8 times	Over-/Under Temperature at Laser diode	
	Green LED blinks 3 times	Missing Extension Board	
	LED blinks 2 times	Approaching End of Life	
	Other	Other warnings	
Red LED blinking, Green LED giving blink code		Failure Status, green blink code indicates failure condition (communication channels are active)	
Red LEDblinking	Green LED blinks 13 times	Pulse Duration Error	
	Green LED blinks 1 times	Emergency Shutdown Detected	
	Other	Other Failures	
Red, Green, Yellow LED blinking synchronously		Power Down Status, System waiting for switching supplies off.	

## 4.7 Typical operating errors

The most common operating error is caused by an insufficient thermal coupling of the ZFSM to the heat sink. In that case the temperature will increase in a short time and the LDU will switch off the laser when it exceeds the specified temperature limits. The user can read out the temperature via TWI protocols or measure the case temperature directly.

## 5. Safety functions

The ZFSM laser driver unit (LDU) includes many techniques to support a fail-safe laser system according to EN ISO 13849 Kat-3, PL-D. The product incorporates a dual channel system with isolated main function and safety functions. The software of the main microcontroller unit (MMCU) is a class-A software, which has no capability to switch on the laser on its own nor change the laser power. A secondary microcontroller unit (SMCU)

 Z-Laser Optoelektronik GmbH Merzhauser Str. 134 D-79100 Freiburg Tel.: (0761)29644-44 Fax: (0761)29644-55/56	Product <b>ZFSM</b>	Date: <b>2017.01.24</b>	Page: <b>40 of 64</b>
	Advanced Information <b>Document-ID: UI-ZL-120005-2.0-2017-01-24</b>		Author: <b>TR</b>

verifies every important process and releases it. All diagnosis and security functions are using resources independent from main functions (power supply, reference voltages, clock generation,,...) Time critical diagnosis and security functions are built by discrete electronics circuits.

Optional configurations require a user password to be transmitted via TWI in order to operate the laser, these cannot be switched on without using a host computer system and without controlling a system\_enable input signal (can be used as hardware interlock).

 Z-Laser Optoelektronik GmbH Merzhauser Str. 134 D-79100 Freiburg Tel.: (0761)29644-44 Fax: (0761)29644-55/56	Product <b>ZFSM</b>	Date: <b>2017.01.24</b>	Page: <b>41 of 64</b>
	Advanced Information <b>Document-ID: UI-ZL-120005-2.0-2017-01-24</b>		Author: <b>TR</b>

Functional Block Diagram, View on the LDU's safety and surveillance concept:

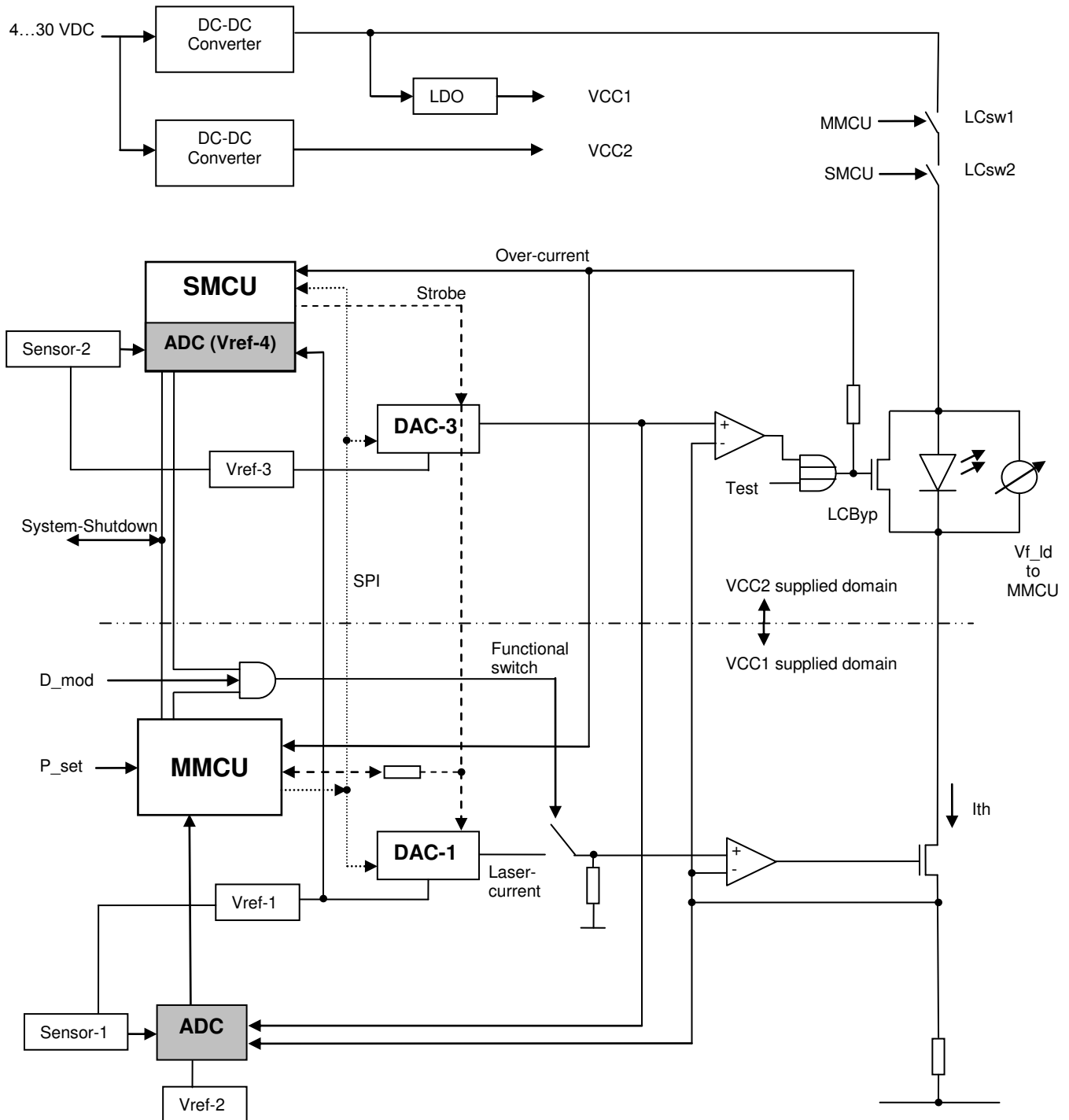

 Z-Laser Optoelektronik GmbH Merzhauser Str. 134 D-79100 Freiburg Tel.: (0761)29644-44 Fax: (0761)29644-55/56	Product <b>ZFSM</b>	Date: <b>2017.01.24</b>	Page: <b>42 of 64</b>
	Advanced Information <b>Document-ID: UI-ZL-120005-2.0-2017-01-24</b>		Author: <b>TR</b>

## 5.1 Diagnosis and security functions

Feature	Reference
<p><b>Laser diode supervision</b></p> <p>During the initial system calibration routine the physical parameters of the laser diode (threshold current, forward voltage) are recorded. In the lifetime of the laser these parameters are measured and verified.</p>	
<p><b>Independent Hardware resources for main functions and surveillance tasks.</b></p> <p>Main MCU (MMCUC) runs with independent voltage supply (VCC-1 derived from primary power supply) and independent clock generation.</p> <p>Surveillance MCU (SMCU) operating from independent supply voltage (VCC2 derived from primary power supply) and independent clock generation. Supervises critical tasks performed by the MMCUC.</p> <p>Independent DA-Converters (DAC) for laser current and over current detection, operating from independent voltage supplies and independent reference voltages.</p> <p>AD-Converters (ADC) to supervise critical system parameters operating from independent reference voltages.</p>	
<p><b>Redundant sensors for laser system parameters</b></p> <p>For each laser diode two redundant sensors are provided.</p> <p>The first sensor is operating from a first reference voltage, is being converted by a first high-precision ADC operating from a second reference voltage and is being used by the MMCUC.</p> <p>The second sensor is operating from a third reference voltage, is being converted by a second ADC operating from a fourth reference voltage and is being used by the SMCUC. This sensor is only used for plausibility checks of all derived system settings.</p> <p>The SMCUC recalculates and verifies the correct settings.</p>	
<p><b>Functional safety of method to program the laser power</b></p> <p>The laser power can be changed during a continuous operation by reprogramming P_set.</p> <p>P_set is programmed by the operator in a CRC secured telegram to the MMCUC. The telegram transports seven bytes (see section 0)</p> <ol style="list-style-type: none"> <li>1. the device-ID</li> <li>2. the command byte</li> <li>3. the new power value P_set (as percentage of nominal power)</li> <li>4. a CRC-P calculated with a polynomial P1 and the power value</li> <li>5. the sub address of the target LDU</li> <li>6. a CRC-ADR calculated with a polynomial P1 and the sub address of the</li> </ol>	

 Z-Laser Optoelektronik GmbH Merzhauser Str. 134 D-79100 Freiburg Tel.: (0761)29644-44 Fax: (0761)29644-55/56	Product <b>ZFSM</b>	Date: <b>2017.01.24</b>	Page: <b>43 of 64</b>
	Advanced Information <b>Document-ID: UI-ZL-120005-2.0-2017-01-24</b>		Author: <b>TR</b>

<p>target LDU</p> <p>7. a CRC-TGM calculated with a polynomial P2 and the entire telegram payload</p> <p>The MMCU decodes CRC-TGM with P2 and verifies the correct transmission of the entire telegram payload.</p> <p>It then sends the power value as well as CRC-P and CRC-A to the SMCU.</p> <p>The sub address of the LDU is firmly programmed into the MMCU and the SMCU.</p> <p>P1 is only resident in the SMCU. The MMCU receives the approval from the SMCU.</p> <p>The SMCU verifies then the integrity of the received P_set value and the target sub address. Thus both MCU's have a correct base figure to calculate and verify the new laser current values.</p>	
<p><b>Functional safety of method to control the laser power</b></p> <p>DAC-1 generates an accurate Laser Current for the laser diode  DAC-3 generates a maximum current level for a permanent current surveillance.</p> <p>After calculating new laser current settings for the functional DAC-1 a limit current value is written to DAC-3 that program a very fast over current supervision. An over-current occurrence closes the current bypass (LCByP) in less than 1 µs. (FTT/FTZ)</p> <p>Both, the MMCU and the SMCU monitor the over current detector. Upon an over current occurrence a system wide shut down is initiated by either the MMCU or the SMCU (Reaction time &lt; 10 ms).</p> <p>All DAC's are programmed by the MMCU via SPI protocol. DAC-1 and DAC-3 are addressed by two dedicated CS signals. The SMCU is addressed by an OR-combined CS of all, however all CS signals are routed to SMCU-ports individually. Thus the SMCU can verify the detailed DAC programming procedure.</p> <p>The SMCU recalculates and verifies the four DAC settings and validates them by sending a "strobe" pulse to the DACs' output stages. Thus the new DAC-settings become effective. The MMCU must verify that the strobe pulse has been issued.</p> <p>In case the SMCU fails in verifying the new DAC settings no strobe is issued, the system-shutdown becomes active and the systems enters the failure state.</p> <p>If no strobe has been issued but the SMCU has not initiated the system-shutdown, the MMCU takes over and activates the system-shutdown. The failure state is entered, however with a different failure indication.</p> <p>The MMCU monitors the output values of DAC-3 and the original laser current in real-time with a very high accuracy. Therefore a very fast 12-Bit ADC is</p>	

 Z-Laser Optoelektronik GmbH Merzhauser Str. 134 D-79100 Freiburg Tel.: (0761)29644-44 Fax: (0761)29644-55/56	Product <b>ZFSM</b>	Date: <b>2017.01.24</b>	Page: <b>44 of 64</b>
	Advanced Information <b>Document-ID: UI-ZL-120005-2.0-2017-01-24</b>		Author: <b>TR</b>

<p>used.</p> <p>SFTY: For CW-Operation mode the MMCU monitors the laser currents and conducts a system wide emergency shutdown upon failures. (reaction time &lt; 10ms). This does not apply for digitally modulated use cases.</p> <p>SFTY: For pulse triggered operating modes (conducted by an AddOn module) the MMCU checks critical pulse modes. E.g. a laser-on phase longer than 1 second leads to an emergency shutdown of the entire system (ERROR Bit 22). Critical pulse modes can be custom programmable via TWI command or can be a hard coded into a customized firmware.</p>	
<p><b>Power up checks of the MMCU and the SMCU</b></p> <p>Safety surveillance functions are tested to ensure that no single failures are accumulated. In every system startup phase the correct function is being self-tested as well as typical failure conditions.</p> <ol style="list-style-type: none"> <li>1. RAM test, ROM test, EEPROM test of SMCU and MMCU</li> <li>2. DAC-1 ... DAC-4</li> <li>3. Over Current Detecion</li> <li>4. System Shut-Down</li> <li>5. MMCU and SMCU setup the system for a new laser current</li> <li>6. Power Domain test of MMCU and SMCU</li> <li>7. Tests of Vref's</li> <li>8. Tests of sensor devices</li> </ol> <p><b>Attention:</b> In case of a failure it might not be possible to conduct any subsequent procedure in the planned way! Only the system shutdown is ensured because both MCU's are controlling each other.</p>	
<p><b>Permanent monitoring of the MCU's sanity</b></p> <p>To prevent an undetected accumulation of faults both MCU's conduct a permanent cross check (Heartbeat check). The MMC's send alternating tokens every 10 milliseconds to each other. After 10 missing tokens either MCU's assume that the counterpart is unavailable and shuts down the entire system (EEROR Bit 21)</p>	
<p><b>Independent methods of laser power shut-down</b></p> <p>Ordinary functional switch via digital modulation control (X2.2). This switch must be released by MMCU and SMCU to take effect.</p> <p>General disable via global system enable (X1.7) control. This control signal initiates the MMCU to ordinary enable or disables the LDU. DAC's are programmed, the laser diode is powered and all switches are enabled / released.</p> <p>System shut-down by MMCU or SMCU via independent laser power supply switches. In emergency states both, the SMCU and the MMCU can disable the laser diodes current supply.</p> <p>Over current shut-down via laser current bypass switch (LCByp). This is a very fast switch in emergency states to short the laser diodes terminals. Every over</p>	

 Z-Laser Optoelektronik GmbH Merzhauser Str. 134 D-79100 Freiburg Tel.: (0761)29644-44 Fax: (0761)29644-55/56	Product <b>ZFSM</b>	Date: <b>2017.01.24</b>	Page: <b>45 of 64</b>
	Advanced Information <b>Document-ID: UI-ZL-120005-2.0-2017-01-24</b>		Author: <b>TR</b>

current occurrence will issue a current bypass for at least 1 ms (prolonged by a monoflop) and alarm the MCU's. A system shutdown can then be conducted by the SMCU or the MMCU.	
<b>MFDT</b> (multi failure detection time, German: „Mehrfehler-Erkennungszeit“ MFEZ) System sanity checks are conducted with every power cycle. Thus the maximum MFDT is defined as longest on-time of the LDU. After 24 h a warning is issued (X1.4 = low / active) and a new self-test is requested.	
<b>FTT</b> (Failure tolerance time, German: „Fehlertoleranz-Zeit“ – FTZ) A potentially harmful laser power must be detected and prevented within less than 1µs. <b>SFTY</b> : A laser power that leaves the range of +/- 20% of the pre-set power value must be detected and prevented within 10 ms.	

 Z-Laser Optoelektronik GmbH Merzhauser Str. 134 D-79100 Freiburg Tel.: (0761)29644-44 Fax: (0761)29644-55/56	Product <b>ZFSM</b>	Date: <b>2017.01.24</b>	Page: <b>46 of 64</b>
	Advanced Information <b>Document-ID: UI-ZL-120005-2.0-2017-01-24</b>		Author: <b>TR</b>

## 6. AddOn Functions

### 6.1 Pulse Generator

The pulse generator AddOn module provides a user programmable sequencer of laser pulses. The generated laser pulse sequences are supervised by a second microcontroller unit (MMCUC) to preserve the laser safety even in very application specific situations.

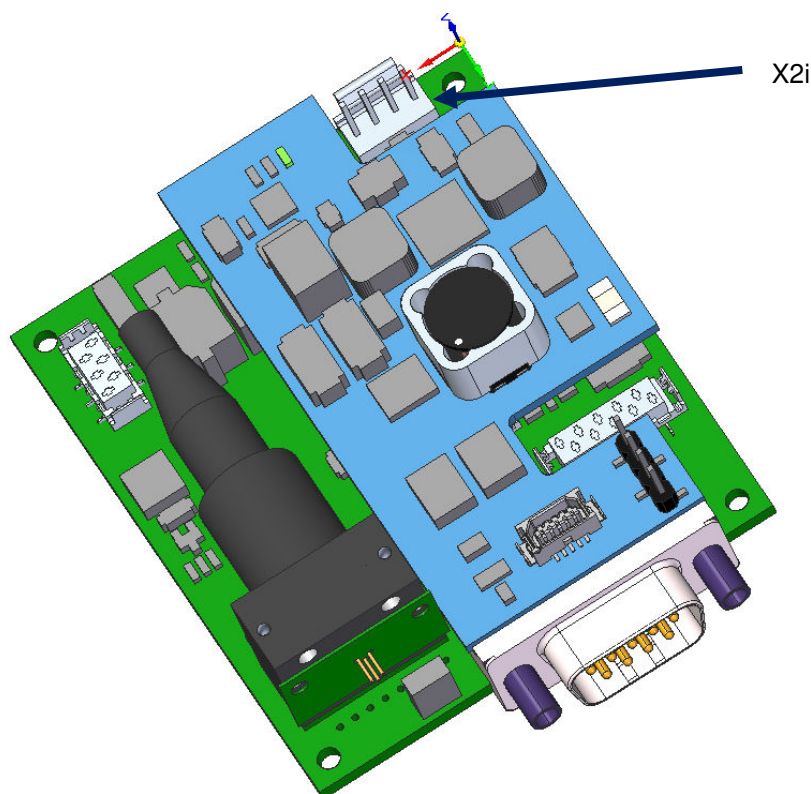

A laser pulse sequence is issued by a rising edge of the trigger input (X2i.3 if configured as trigger input by firmware or by a special TWI command). The module can be configured to terminate a running pulse sequence by the falling edge of the trigger input.

The pulse sequence is stored and executed by a small microcontroller unit on the AddOn module. The user can program a custom pattern and store it in a non-volatile memory (EEPROM). Once a valid pattern is stored it can be loaded after every power-up. Thus the system operates as a customized pulse laser without any further setup procedure.

#### 6.1.1 Modes of pulsed operation

The pulse generator AddOn module can operate in different modes. The operating mode can be programmed by a “pattern mode” byte and stored in a non-volatile memory (EEPROM – default 0x00). The stored mode byte is always loaded and applied during system startup.

Feature		Reference
Bit 0	EEPROM_STARTUP_RELOAD 0: no pulse pattern is loaded at system startup time (default) 1: a pulse pattern stored in the EEPROM is loaded at system startup time	

 Z-Laser Optoelektronik GmbH Merzhauser Str. 134 D-79100 Freiburg Tel.: (0761)29644-44 Fax: (0761)29644-55/56	Product <b>ZFSM</b>	Date: <b>2017.01.24</b>	Page: <b>47 of 64</b>
	Advanced Information <b>Document-ID: UI-ZL-120005-2.0-2017-01-24</b>		Author: <b>TR</b>

Bit 1	<b>INTERRUPT_PATTERN</b> 0: a running pulse pattern cannot be interrupted (default) 1: a falling edge of the trigger input interrupts a running pulse pattern and turns off the laser	
Bit 3	<b>CONTINUOUS_PATTERN</b> 0: a pattern is executed only once (default) 1: a running pattern is auto-repeated	

### 6.1.2 Functional Safety

The laser operations that are conducted by the AddOn module are supervised by the main microcontroller unit (MMCUC). To support the single fault safety, both use independent resources for power supply and clock generation.

Various safety limits for the pulse generator unit are hard coded into the customized firmware:

1. The maximum laser-on time is defined to be 1 second (A hardware timer running in the MMCUC measures the total continuous ON-time of the laser and switches it off after 1 second. 1 millisecond later the laser will be back under control of the pulse generator unit. The timer will be reset upon reaching 1000 milliseconds or upon 2 milliseconds of laser-OFF time)
2. The maximum pulse sequence length is defined to be 10 seconds (Starting from the first laser-ON event of a started pulse sequence a hardware timer running in the MMCUC forces a transition to the Standby Status. Thus the laser is completely disabled. In order to start a new pulse sequence the user must conduct a regular transition to the Ready Status, i.e. transmitting a valid password via TWI interface. See 4.4 )

To support system integration work these hard coded safety limits can be disabled in a protected customer service mode.

 Z-Laser Optoelektronik GmbH Merzhauser Str. 134 D-79100 Freiburg Tel.: (0761)29644-44 Fax: (0761)29644-55/56	Product <b>ZFSM</b>	Date: <b>2017.01.24</b>	Page: <b>48 of 64</b>
	Advanced Information <b>Document-ID: UI-ZL-120005-2.0-2017-01-24</b>		Author: <b>TR</b>

### 6.1.3 Programming the pulse generator

New TWI commands to control the pulse generator module:

Feature		Reference																										
<p><b>SET_PULSE_CONTROL</b> - Programs a single phase for the pulse sequence. "Phase" refers to an indexed state of the laser for a defined period of time. A pulse pattern is then built by a sequence of indexed phases, the first phase is always indexed by "0" and is always a "laser-on" phase. Subsequent odd phase indices (1,3,5...) refer to "laser-off" phases, even phase indices (2,4,6...) refer to "laser-on" phases.</p> <p>The trigger event is a rising edge of X2.2</p> <p>Arbitrary numbers of events can be programmed in a sequence.</p> <table border="1" data-bbox="210 929 1174 1034"> <tr> <td>WR-Device-ID</td> <td>CMD (0xA0)</td> <td>Sub-Address</td> <td>Sub-CMD</td> <td>Byte-1</td> <td>Byte-2</td> </tr> <tr> <td>Byte-3</td> <td>CRC-TGM</td> <td colspan="4"></td> </tr> </table> <table border="1" data-bbox="210 1055 1174 1111"> <tr> <td>RD-Device-ID</td> <td>System Status</td> <td>Gen-Status</td> <td>RD-Byte-1</td> <td>RD-Byte-2</td> <td>CRC-TGM</td> </tr> </table> <p>(RD transmission can be repeated)</p> <p><b>Set of Sub-CMD codes:</b></p> <table border="1" data-bbox="188 1249 1252 2040"> <tr> <td>0x05</td> <td> <b>SET_PHASE</b>  Program an Event in the format "Sub-CMD, index, high byte, low byte, CRC" <ol style="list-style-type: none"> <li>"Index" from 0 to 63 (index 0 is reserved for a "laser-on" phase, every subsequent phase toggles the laser light status)</li> <li>"High-byte, Low-byte" program a duration of this phase in milliseconds.  The allowed maximum for a "laser-on" phase is 999.  The minimum "laser-off" phase should be 2 to reset the safety timer in the MMCU.</li> </ol> <p>0x0000 is interpreted as invalid phase – this phase will not be executed (can be used to start a sequence with a laser-off phase).  0xffff is interpreted as termination of the pulse sequence. The laser will be switched off.</p> </td> </tr> <tr> <td>0x06</td> <td> <b>READ_PHASE</b>  Read a programmed phase with given index in the format "Sub-CMD, index, xx, xx, CRC". Both data bytes are don't care in the write transmission but being returned in the following read transmission. </td> </tr> <tr> <td>0x07</td> <td> <b>SAVE_PATTERN_TO_EEPROM</b>  Writes the entire pulse pattern into the EEPROM that has been programmed before. Format: "Sub-SMD, xx, xx, xx CRC" </td> </tr> <tr> <td>0x08</td> <td> <b>LOAD_PATTERN_FROM_EEPROM</b>  Deletes the current pulse pattern and load the pattern stored in the EEPROM. </td> </tr> </table>		WR-Device-ID	CMD (0xA0)	Sub-Address	Sub-CMD	Byte-1	Byte-2	Byte-3	CRC-TGM					RD-Device-ID	System Status	Gen-Status	RD-Byte-1	RD-Byte-2	CRC-TGM	0x05	<b>SET_PHASE</b> Program an Event in the format "Sub-CMD, index, high byte, low byte, CRC" <ol style="list-style-type: none"> <li>"Index" from 0 to 63 (index 0 is reserved for a "laser-on" phase, every subsequent phase toggles the laser light status)</li> <li>"High-byte, Low-byte" program a duration of this phase in milliseconds.  The allowed maximum for a "laser-on" phase is 999.  The minimum "laser-off" phase should be 2 to reset the safety timer in the MMCU.</li> </ol> <p>0x0000 is interpreted as invalid phase – this phase will not be executed (can be used to start a sequence with a laser-off phase).  0xffff is interpreted as termination of the pulse sequence. The laser will be switched off.</p>	0x06	<b>READ_PHASE</b> Read a programmed phase with given index in the format "Sub-CMD, index, xx, xx, CRC". Both data bytes are don't care in the write transmission but being returned in the following read transmission.	0x07	<b>SAVE_PATTERN_TO_EEPROM</b> Writes the entire pulse pattern into the EEPROM that has been programmed before. Format: "Sub-SMD, xx, xx, xx CRC"	0x08	<b>LOAD_PATTERN_FROM_EEPROM</b> Deletes the current pulse pattern and load the pattern stored in the EEPROM.	
WR-Device-ID	CMD (0xA0)	Sub-Address	Sub-CMD	Byte-1	Byte-2																							
Byte-3	CRC-TGM																											
RD-Device-ID	System Status	Gen-Status	RD-Byte-1	RD-Byte-2	CRC-TGM																							
0x05	<b>SET_PHASE</b> Program an Event in the format "Sub-CMD, index, high byte, low byte, CRC" <ol style="list-style-type: none"> <li>"Index" from 0 to 63 (index 0 is reserved for a "laser-on" phase, every subsequent phase toggles the laser light status)</li> <li>"High-byte, Low-byte" program a duration of this phase in milliseconds.  The allowed maximum for a "laser-on" phase is 999.  The minimum "laser-off" phase should be 2 to reset the safety timer in the MMCU.</li> </ol> <p>0x0000 is interpreted as invalid phase – this phase will not be executed (can be used to start a sequence with a laser-off phase).  0xffff is interpreted as termination of the pulse sequence. The laser will be switched off.</p>																											
0x06	<b>READ_PHASE</b> Read a programmed phase with given index in the format "Sub-CMD, index, xx, xx, CRC". Both data bytes are don't care in the write transmission but being returned in the following read transmission.																											
0x07	<b>SAVE_PATTERN_TO_EEPROM</b> Writes the entire pulse pattern into the EEPROM that has been programmed before. Format: "Sub-SMD, xx, xx, xx CRC"																											
0x08	<b>LOAD_PATTERN_FROM_EEPROM</b> Deletes the current pulse pattern and load the pattern stored in the EEPROM.																											

 Z-Laser Optoelektronik GmbH Merzhauser Str. 134 D-79100 Freiburg Tel.: (0761)29644-44 Fax: (0761)29644-55/56	Product <b>ZFSM</b>	Date: <b>2017.01.24</b>	Page: <b>49 of 64</b>
	Advanced Information <b>Document-ID: UI-ZL-120005-2.0-2017-01-24</b>		Author: <b>TR</b>

	Format: "Sub-CMD, xx, xx, xx, CRC"																
0x09	SAVE_PATTERN_MODE_TO_EEPROM Stores the written pattern mode byte into the EEPROM memory																
0x0A	READ_PATTERN_MODE Read the programmed pattern mode byte																
0x0B	WRITE_PATTERN_MODE Program the pattern mode byte																
For System Status Bits refer to 4.3.3																	
<b>Generator Status:</b>																	
Bit 0	BUSY Command execution by Pulse Generator module is busy Attention: this is covered by the busy system status, so this bit will never be seen in the status "1".																
Bit 1	OK Command execution is completed successfully by the pulse generator module																
Bit 2	NOK Command execution was not ok (covered by error state)																
Bit 3	ERROR Command execution encountered an error in the pulse generator module																
Bit 4	TIMEOUT A command timeout occurred																
Bit 5	CRC-ERROR																
Bit 6	CMD-OORANGE The command (data payload) was out of range, e.g. a laser on-time of more than 999 ms was programmed.																
<b>Set Customer Service Mode</b> - Enters a password protected Service Mode that enables the operator to change extended mode settings.																	
<table border="1" style="width: 100%; border-collapse: collapse;"> <tr> <td style="background-color: #d9ead3;">WR-Device-ID</td> <td style="background-color: #d9ead3;">CMD (0xB7)</td> <td style="background-color: #d9ead3;">Sub Address</td> <td style="background-color: #d9ead3;">Parameter 1</td> <td style="background-color: #d9ead3;">Password Hi</td> <td style="background-color: #d9ead3;">Password Lo</td> </tr> <tr> <td style="background-color: #d9ead3;">CRC-PARM</td> <td style="background-color: #d9ead3;">CRC-ADR</td> <td style="background-color: #d9ead3;">CRC-TGM</td> <td></td> <td></td> <td></td> </tr> </table>						WR-Device-ID	CMD (0xB7)	Sub Address	Parameter 1	Password Hi	Password Lo	CRC-PARM	CRC-ADR	CRC-TGM			
WR-Device-ID	CMD (0xB7)	Sub Address	Parameter 1	Password Hi	Password Lo												
CRC-PARM	CRC-ADR	CRC-TGM															
<table border="1" style="width: 100%; border-collapse: collapse;"> <tr> <td style="background-color: #d9ead3;">RD-Device-ID</td> <td style="background-color: #d9ead3;">System Status</td> <td style="background-color: #d9ead3;">CRC-TGM</td> <td colspan="3">(RD transmission can be repeated)</td> </tr> </table>						RD-Device-ID	System Status	CRC-TGM	(RD transmission can be repeated)								
RD-Device-ID	System Status	CRC-TGM	(RD transmission can be repeated)														
For the prototypes the password is 0xAFCD																	
Parameter 1:																	
0x00	Customer Service Mode Off																
0x01	Customer Service Mode On																

 Z-Laser Optoelektronik GmbH Merzhauser Str. 134 D-79100 Freiburg Tel.: (0761)29644-44 Fax: (0761)29644-55/56	Product <b>ZFSM</b>	Date: <b>2017.01.24</b>	Page: <b>50 of 64</b>
	Advanced Information <b>Document-ID: UI-ZL-120005-2.0-2017-01-24</b>		Author: <b>TR</b>

**Set\_Extended\_Mode** – only writeable in “Customer Service Mode”. Controls the behavior of the AddOn Board.

WR-Device-ID	CMD (0xA9)	Sub Address	Mode Byte 3	Mode Byte 2	Mode Byte 1
Mode Byte 0	CRC-TGM				
RD-Device-ID	System Status	CRC-TGM	(RD transmission can be repeated)		

Mode Byte 3: reserved  
Mode Byte 2: reserved  
Mode Byte 1: reserved  
Mode Byte 0: Bit 5,6,7 reserved

Bit 0	Auto Select COM Port (default 0 = off)
Bit 1	TEC Driver Enable (default depending on product configuration)
Bit 2	NTC Case Enable (default depending on product configuration)
Bit 3	Check NTC Diff Disable (default 0 = checks are enabled)
Bit 4	<b>Pulse Sequence Timer Enable (default 1 = safety timer enabled)</b>

**Get\_Extended\_Mode** - Reads the settings of the AddOn Board. Does not require to enter the “Customer Service Mode”

WR-Device-ID	CMD (0xA8)	Sub Address	CRC-TGM		
RD-Device-ID	System Status	Mode Byte 3	Mode Byte 2	Mode Byte 1	Mode Byte 0
CRC-TGM					

(Status followed by CRC and trailing fill bytes when data cannot be returned instantaneously)

For the mapping of the mode bytes please refer to the “Set\_Extended\_Mode” Command

## 6.1.4 Example Pulse Patterns

As an example some pulse patterns are programmed

### 1. Example (for Sub Address 0x00)



WR-Device-ID	0xA0	0x00	0x05	0x00	0x00	0x00	0x8B	Laser-on phase (suppressed)
RD-Device-ID	0x00	0x02	d.c.	d.c.	CRC-TGM			
WR-Device-ID	0xA0	0x00	0x05	0x01	0x00	0x14	0xDC	Laser-off phase
RD-Device-ID	0x00	0x02	d.c.	d.c.	CRC-TGM			
WR-Device-ID	0xA0	0x00	0x05	0x02	0x00	0x3C	0xD9	Laser-on phase
RD-Device-ID	0x00	0x02	d.c.	d.c.	CRC-TGM			
WR-Device-ID	0xA0	0x00	0x05	0x03	0x00	0x14	0x93	Laser-off phase
RD-Device-ID	0x00	0x02	d.c.	d.c.	CRC-TGM			
WR-Device-ID	0xA0	0x00	0x05	0x04	0x00	0x14	0xE9	Laser-on phase
RD-Device-ID	0x00	0x02	d.c.	d.c.	CRC-TGM			
WR-Device-ID	0xA0	0x00	0x05	0x05	0xFF	0xFF	0x0A	Laser-off (terminate)
RD-Device-ID	0x00	0x02	d.c.	d.c.	CRC-TGM			

 Z-Laser Optoelektronik GmbH Merzhauser Str. 134 D-79100 Freiburg Tel.: (0761)29644-44 Fax: (0761)29644-55/56	Product <b>ZFSM</b>	Date: <b>2017.01.24</b>	Page: <b>52 of 64</b>
	Advanced Information <b>Document-ID: UI-ZL-120005-2.0-2017-01-24</b>		Author: <b>TR</b>

## 2. Example (for Sub Adress 0x00)

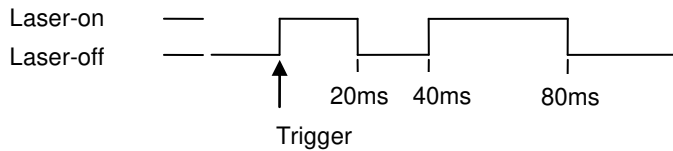

WR-Device-ID	0xA0	0x00	0x05	0x00	0x00	0x14	0x77	Laser-on phase
RD-Device-ID	0x00	0x02	d.c.	d.c.	CRC-TGM			
WR-Device-ID	0xA0	0x00	0x05	0x01	0x00	0x14	0xDC	Laser-off phase
RD-Device-ID	0x00	0x02	d.c.	d.c.	CRC-TGM			
WR-Device-ID	0xA0	0x00	0x05	0x02	0x00	0x28	0x25	Laser-on phase
RD-Device-ID	0x00	0x02	d.c.	d.c.	CRC-TGM			
WR-Device-ID	0xA0	0x00	0x05	0x03	0xFF	0xFF	0xDB	Laser-off (terminate)
RD-Device-ID	0x00	0x02	d.c.	d.c.	CRC-TGM			

## 6.2 USB Interface

## 6.3 TEC Module

 Z-Laser Optoelektronik GmbH Merzhauser Str. 134 D-79100 Freiburg Tel.: (0761)29644-44 Fax: (0761)29644-55/56	Product <b>ZFSM</b>	Date: <b>2017.01.24</b>	Page: <b>53 of 64</b>
	Advanced Information <b>Document-ID: UI-ZL-120005-2.0-2017-01-24</b>		Author: <b>TR</b>

## 7. Drawings

### 7.1 Laser Module

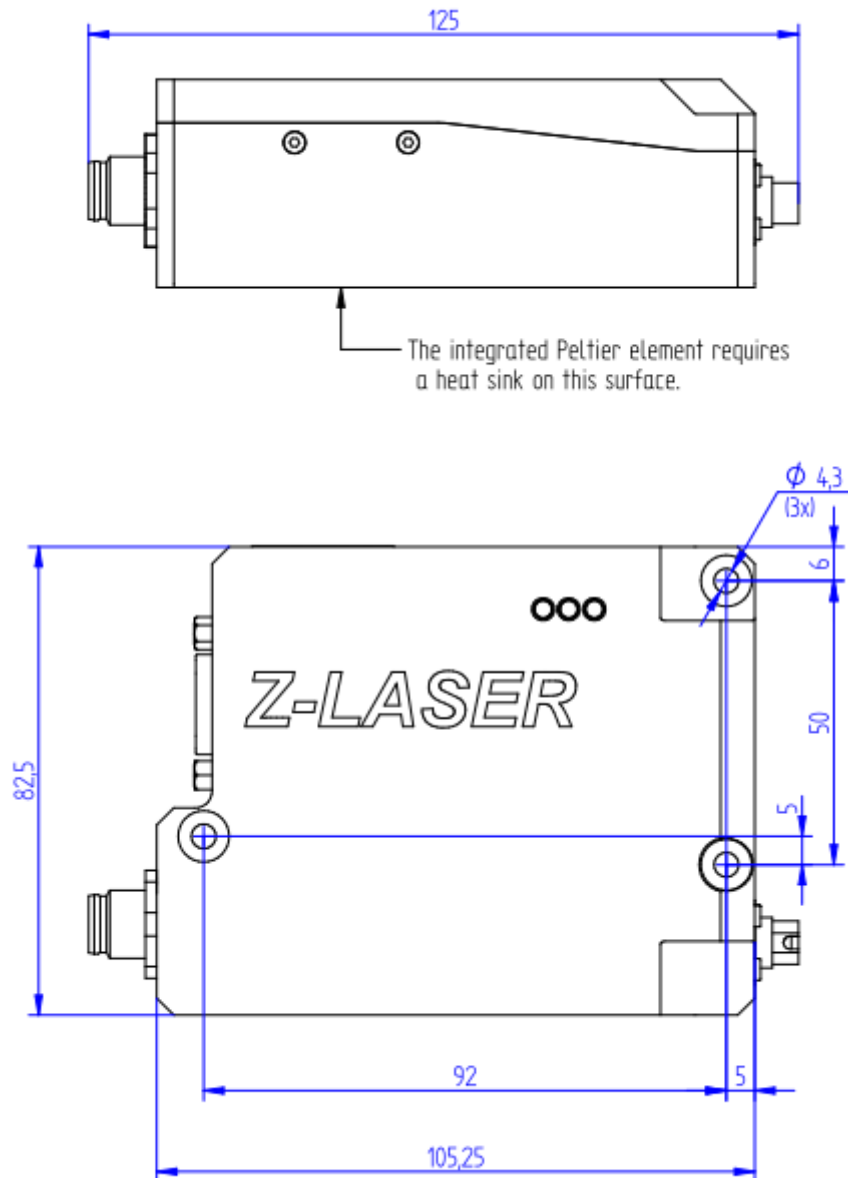

### 7.2 Standard barreled optics

Clamp area  $\varnothing$  20mm



 Z-Laser Optoelektronik GmbH Merzhauser Str. 134 D-79100 Freiburg Tel.: (0761)29644-44 Fax: (0761)29644-55/56	Product <b>ZFSM</b>	Date: <b>2017.01.24</b>	Page: <b>54 of 64</b>
	Advanced Information <b>Document-ID: UI-ZL-120005-2.0-2017-01-24</b>		Author: <b>TR</b>

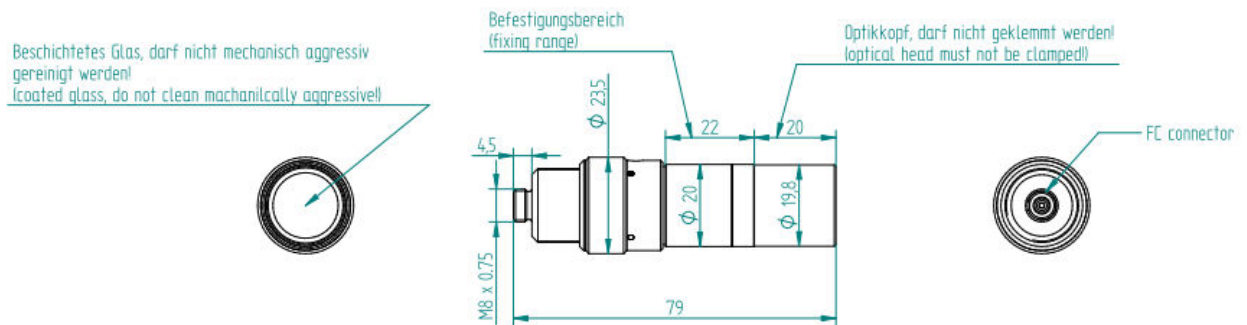
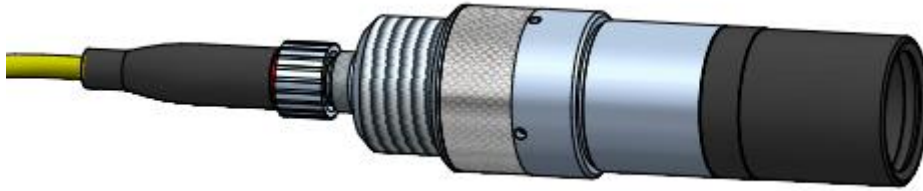

### Optics Module of ZFSM

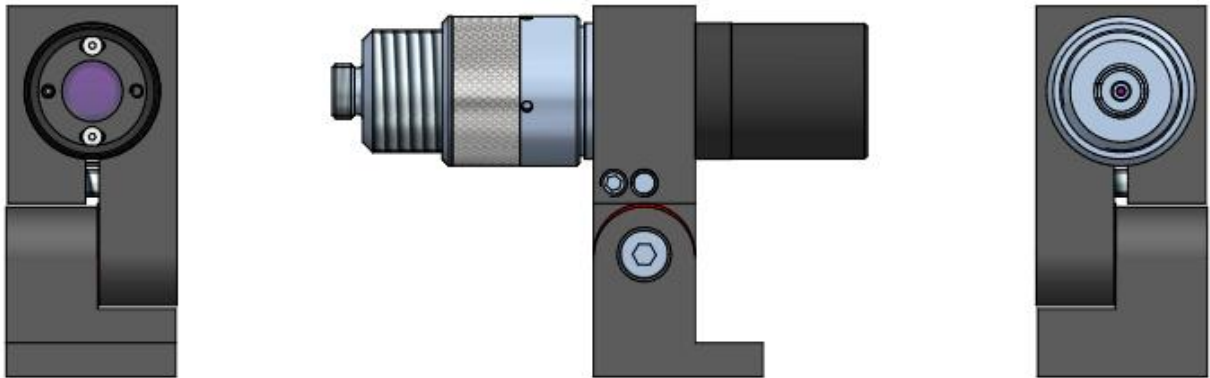

Example for clamping the optics module

 Z-Laser Optoelektronik GmbH Merzhauser Str. 134 D-79100 Freiburg Tel.: (0761)29644-44 Fax: (0761)29644-55/56	Product <b>ZFSM</b>	Date: <b>2017.01.24</b>	Page: <b>55 of 64</b>
	Advanced Information <b>Document-ID: UI-ZL-120005-2.0-2017-01-24</b>		Author: <b>TR</b>

## 8. Product Labelling

This “ZFSM Fiber” product is labelled as follows.  
If one of these labels is missing, do not operate the laser.



## 9. Product Warranty

Z-LASER guarantees its “ZFSM” products to be free of material and workmanship defects for one year from the date of shipment. This warranty is in lieu of all other guarantees expressed or implied and does not cover incidental or consequential loss.

Any modification of the product voids the warranty. Moreover it will bear the risk of changing the laser class of the product (Refer to Chapter 16 “Laser Safety”).

## 10. Service

No special service measures have to be taken to preserve the specified functionality. The degradation with aging of the laser diode can be compensated for by adjusting the laser current statically or dynamically. The laser modules are shipped with enough headroom for an operating time of at least 8,000 hours.

Z-Laser can guarantee a MTTF of at least 10,000 hours for the ZFSM laser module when operated within the specified temperature limits. Most likely the MTTF is significantly higher. However it degrades by 50% with every 10°C.

The accumulated ON-time of the laser is tracked by the microprocessor and can be read via a TWI telegram. Other parameters can be read that give an indication of module aging as well (laser current needed to yield a certain optical output power). Thus it can be decided when a spare unit needs to be provided or when the target system needs service.

 Z-Laser Optoelektronik GmbH Merzhauser Str. 134 D-79100 Freiburg Tel.: (0761)29644-44 Fax: (0761)29644-55/56	Product <b>ZFSM</b>	Date: <b>2017.01.24</b>	Page: <b>56 of 64</b>
	Advanced Information <b>Document-ID: UI-ZL-120005-2.0-2017-01-24</b>		Author: <b>TR</b>

## 11. Disposal

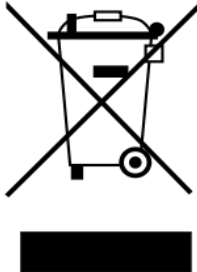

The “ZFSM” product is an electronic device that must not be disposed via ordinary waste bins. The product must be disposed according to EU directive WEEE 2002/96/EG.

## 12. In the case of a damage

The “ZFSM” module is considered damaged when it

- has any visible mechanical damage to electrical contacts or the optical output
- does not emit light
- continuously shows errors after self-test procedures (after power up)
- Light intensity can obviously not be controlled as expected.
- ...

Please contact Z-LASER Service.

When calling Z-LASER, please provide the customer care representative with the following information:

- Your Contact Information
- Serial number or original order number
- Description of problem (i.e., hardware or software)

Ask for a RMA Tracking No.

 Z-Laser Optoelektronik GmbH Merzhauser Str. 134 D-79100 Freiburg Tel.: (0761)29644-44 Fax: (0761)29644-55/56	Product <b>ZFSM</b>	Date: <b>2017.01.24</b>	Page: <b>57 of 64</b>
	Advanced Information <b>Document-ID: UI-ZL-120005-2.0-2017-01-24</b>		Author: <b>TR</b>

## 13. Measurements

### 13.1 Power Stability (Example)

(Prototype of fiber laser module SN# 1300017487)

The long term power stability has been recorded by a 28h measurement. The total power deviation ( $P_{max} - P_{min}$ ) /  $P_{nom}$  is 2.45 %

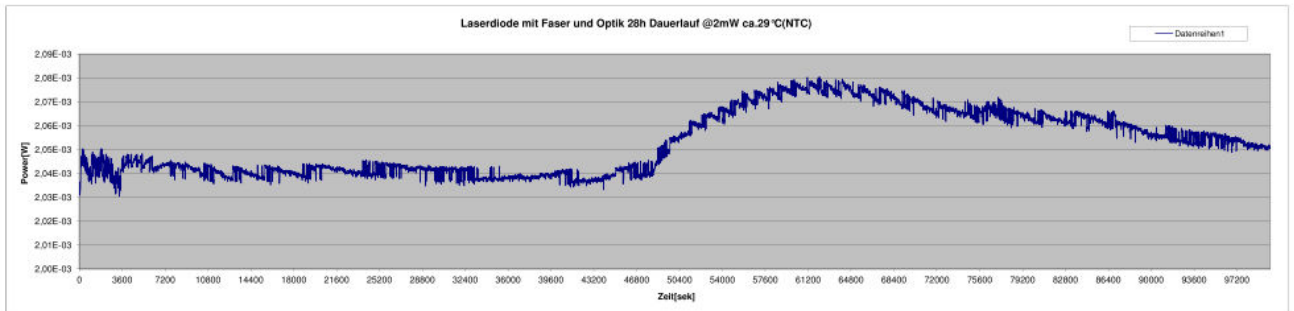

### 13.2 Optical characteristics (Example)

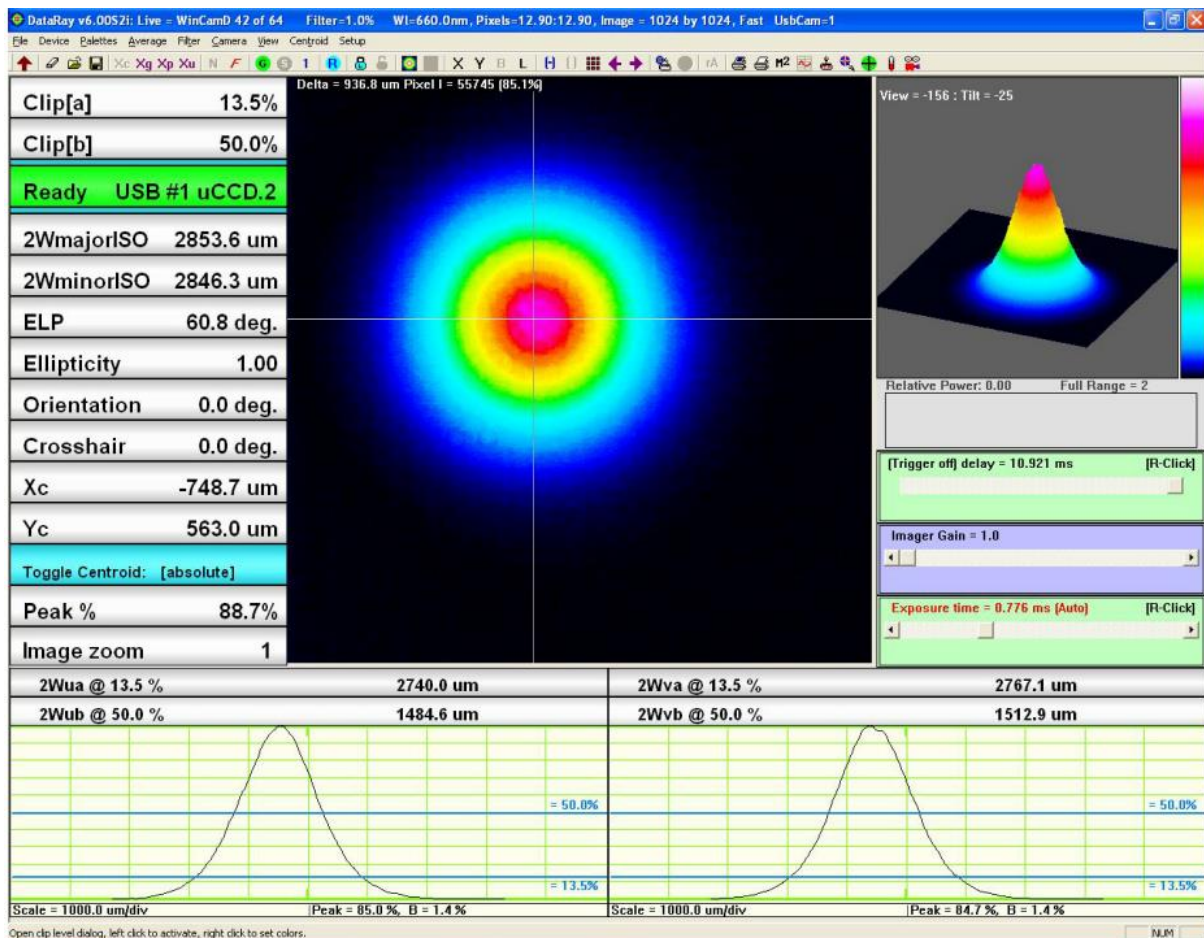

 Z-Laser Optoelektronik GmbH Merzhauser Str. 134 D-79100 Freiburg Tel.: (0761)29644-44 Fax: (0761)29644-55/56	Product <b>ZFSM</b>	Date: <b>2017.01.24</b>	Page: <b>58 of 64</b>
	Advanced Information <b>Document-ID: UI-ZL-120005-2.0-2017-01-24</b>		Author: <b>TR</b>

### 13.3 Errata

The following items are out of line with the initial target spec (2014/01/21)

- Due to variations in the input protective devices X2.2 (digital modulation input) can cause system malfunctions when driven at voltage levels > 4 Volts at certain modulation frequencies.

Please lower the voltage level below 3.8 Volts in case of failures.

- Firmware versions before 4.3.1

### 13.4 Laser classification

This product can be classified as a class 1, 1M, 2M, 3R, 3B laser product depending on optics configuration and power configuration. The classification covers industrial and medical products with regards of EN ISO 13849 Kat-3 PL-D and is based on EN 60825-1:2014 and EN 60601-2-22.

 Z-Laser Optoelektronik GmbH Merzhauser Str. 134 D-79100 Freiburg Tel.: (0761)29644-44 Fax: (0761)29644-55/56	Product <b>ZFSM</b>	Date: <b>2017.01.24</b>	Page: <b>59 of 64</b>
	Advanced Information <b>Document-ID: UI-ZL-120005-2.0-2017-01-24</b>		Author: <b>TR</b>

## 14. Declaration of Conformity

(This declaration refers to the released product. Engineering samples are shipped without full certification and might deviate from the below stated standards. Conformity to EMC standards refer to housed ZFSM versions and do not include customer cabling)

**We therefore confirm that the devices described in the following**

**Name/Product:** ZFSM Fiber

### **ZFSM Fiber**

meets the requirements of the directive 2004/108/EC.

The product is RoHS conform and free of silicon

**The following standards were applied:**

EN 60825-1:2014  
EN 55022:2010  
EN 55011:2010

**The following guidelines were applied:**

2014/30/EU EMC-guideline  
2014/35/EU Low voltage guideline



**Z-LASER Optoelektronik GmbH**  
**Merzhauser Str. 134**  
**79100 Freiburg**

 Z-Laser Optoelektronik GmbH Merzhauser Str. 134 D-79100 Freiburg Tel.: (0761)29644-44 Fax: (0761)29644-55/56	Product <b>ZFSM</b>	Date: <b>2017.01.24</b>	Page: <b>60 of 64</b>
	Advanced Information <b>Document-ID: UI-ZL-120005-2.0-2017-01-24</b>		Author: <b>TR</b>

Freiburg, 30. Nov. 2012

## 15. Glossary

LDU: Laser Driver Unit

EU: Enhancement Unit

EP: Enhancement Port

MCU: Micro Controller Unit (main unit)

MMCUC: Main Micro Controller Unit (functional unit)

SMCU: Secondary Micro Controller Unit (surveillance unit)

TWI: Two Wire Interface, refers to serial user communication interface (I2C or RS232)

SFTY: specification item related to a safety critical laser product.

LCByP: Laser Current Bypass, safety switch to test the system integrity and shut down the laser current in case of emergency

LCsw: Laser current main switch

DAC: Digital to Analog Converter.

ADC: Analog to Digital Converter.

## 16. Laser Safety

Your safety is of the highest importance to us. Please read and follow the following laser safety information before using this product.

Lasers are classified as 1, 1M, 2, 2M, 3R, 3B and 4 according to ISO EN 60825-1

Class 3R, 3B and 4 lasers are not intended for use of uneducated people. The area in which they are operated must be restricted and marked according to laser safety guidelines. The operator of the laser system must provide trained personnel to supervise the observance of laser safety regulations. He must provide protection glasses and other safety prerequisites to the personnel. Generally the operator of the laser system takes full responsibility for the safe installation, marking, handling and operation of the laser.



### CAUTION NOTE

The use of optical instruments with this product will increase Eye hazard. Do not shine laser in the direction of other people or at reflective surfaces that might cause exposure to the human eye!

 Z-Laser Optoelektronik GmbH Merzhauser Str. 134 D-79100 Freiburg Tel.: (0761)29644-44 Fax: (0761)29644-55/56	Product <b>ZFSM</b>	Date: <b>2017.01.24</b>	Page: <b>61 of 64</b>
	Advanced Information <b>Document-ID: UI-ZL-120005-2.0-2017-01-24</b>		Author: <b>TR</b>

The laser radiation emitted from this unit may be harmful.  
Always follow these precautions:

- Avoid direct exposure to the beam.
- Avoid looking at the beam directly.
- Don't modify the laser product and operate it according to the user instructions
- Be aware of and follow the warnings on the safety labels
- To completely shut off power to the unit unplug the unit.
- Cover the fiber output with the safety plug when the unit is operated outside its target system.

Review of reported incidents has demonstrated that accidental eye and skin exposures to laser radiation, and accidents related to the ancillary hazards of a laser or laser system, are most often associated with personnel involved with the use of these systems under the following conditions:

1. Unanticipated eye exposure during alignment
2. Misaligned optics and upwardly directed beams
3. Available eye protection not used
4. Equipment malfunction
5. Improper methods of handling high voltage
6. Intentional exposure of unprotected personnel
7. Operators unfamiliar with laser equipment
8. Lack of protection for ancillary hazards
9. Improper restoration of equipment following service

These hazards can be avoided by a proper understanding of the equipment and by following safe procedures.

The German BGV B2 (Unfallverhütungsvorschrift "Laserstrahlung") gives more information regarding safe operation of laser systems.

### **Equipment:**

Test all lasers, delivery systems, and safety equipment prior to turning on the laser. Appropriate personal protective equipment such as appropriate laser protective eyewear should be worn during such tests. All safety procedures will be followed during service and demonstrations.

### **Eye Protection:**

The greatest risk for personnel using lasers is eye injury to the cornea or retina from direct or reflected laser beams. Protective eyewear with adequate optical density (OD) at the particular wavelength in use must be clearly labelled and worn by all members of the operating team within the NHZ. It is recommended that built-in side shields be used to protect the eyes from tangential beams and scattered reflections. Safety eyewear labelled with the appropriate wavelength and optical density will be available at the entry where each door sign is posted.

**Caution:** Laser Safety Eyewear is not designed for looking directly at a laser beam.

### **Checks:**

 Z-Laser Optoelektronik GmbH Merzhauser Str. 134 D-79100 Freiburg Tel.: (0761)29644-44 Fax: (0761)29644-55/56	Product <b>ZFSM</b>	Date: <b>2017.01.24</b>	Page: <b>62 of 64</b>
	Advanced Information <b>Document-ID: UI-ZL-120005-2.0-2017-01-24</b>		Author: <b>TR</b>

Check the power output of the laser frequently with an appropriate power meter, especially before beginning the procedure. Appropriate eyewear should be worn during such checks. The laser should be placed in a standby mode when not in use, to prevent inadvertent exposure to power/energy.

### Electrical Hazards:

Use of any electrical system may give rise to electrical hazards; consequently, proper grounding and insulation are imperative. Protection against accidental contact with energized conductors by means of a barrier system is the primary methodology to prevent electric shock accidents with laser equipment. Additional electrical safety requirements are imposed upon laser devices, systems, and those who work with them, by the US Department of Labor, OSHA, the National Electrical Code (NFPA 70), and related state and local laws and regulations. These requirements govern equipment connection to the electrical utilization system, electrical protection parameters, and specific safety training. These requirements must be observed with all laser installations.

The following potential problems have frequently been identified during laser facility audits.

1. Uncovered electrical terminals
2. Improperly insulated electrical terminals
3. Hidden "power-up" warning lights
4. Lack of personnel trained in current cardiopulmonary resuscitation practices, or lack of refresher training
5. "Buddy system" not being practiced during maintenance and service
6. Non earth-grounded or improperly grounded laser equipment
7. Non-adherence to the OSHA lock-out standard (29 CFR 1910.147)
8. Excessive wires and cables on floor that create fall or slip hazards

### Emergency Shutoff:

An emergency shutoff switch must be available to the operator or the assistant to rapidly shutdown the equipment. The interlock of the laser is intended to shut down laser power immediately

### Controlled Area:

Authorized personnel, upon entry to an area where lasers are being used, should be provided with personal protective equipment (see Description of Facilities, above). Such controlled area should contain the NHZ, the extent of which is clearly delineated, and should be posted with appropriate laser warning signs specific to the wavelength being used (as described in ANSI Z136.3, Section 4.7). The laser should not be activated when it is necessary to open the door, if the Nominal Hazard Zone (NHZ) extends to the doorway. Glass windows will be covered with shades or filters of appropriate optical density whenever a fiber-optic laser system is operational. No one will be allowed into a laser room unless properly authorized and protected.

### Warning Signs:

Regulation Danger laser signs will be posted at eye level on all doors that access a room where Class 3b and/or Class 4 laser will be operated. These signs will state all required information as described in the ANSI Z136.1 standard, and will be removed when the laser is not in use.

 Z-Laser Optoelektronik GmbH Merzhauser Str. 134 D-79100 Freiburg Tel.: (0761)29644-44 Fax: (0761)29644-55/56	Product <b>ZFSM</b>	Date: <b>2017.01.24</b>	Page: <b>63 of 64</b>
	Advanced Information <b>Document-ID: UI-ZL-120005-2.0-2017-01-24</b>		Author: <b>TR</b>

### Fire Hazards:

Class 4 laser systems represent a fire hazard. Enclosure of Class 4 laser beams can result in potential fire hazards if enclosure materials are likely to be exposed to irradiances exceeding 10 W/cm<sup>2</sup> or beam powers exceeding 0.5 W. The use of flame retardant materials, as defined by the National Fire Protection Association (NFPA), should be encouraged.

Opaque laser barriers e.g., curtains, can be used to block the laser beam from exiting the work area during certain operations. While these barriers can be designed to offer a range of protection, they normally cannot withstand high irradiance levels for more than a few seconds without some damage, e.g., production of smoke, open fire, or penetration. Users of commercially available laser barriers should obtain appropriate fire prevention information from the manufacturer.

Operators of Class 4 lasers should be aware that unprotected wire insulation and plastic tubing can catch fire from intense reflected or scattered beams, particularly from lasers operating at invisible wavelengths.

### Explosion Hazards:

High-pressure arc lamps, filament lamps, and capacitor banks in laser equipment shall be enclosed in housings, which can withstand the maximum explosive pressure resulting from component disintegration. The laser target and elements of the optical train which may shatter during laser operation shall also be enclosed or equivalently protected to prevent injury to operators and observers. Explosive reactions of chemical laser reactants or other laser gases may be a concern in some cases.

### From the German BGV B2 (Unfallverhütungsvorschrift "Laserstrahlung"):

Lasereinrichtungen müssen entsprechend ihrer Klasse und Verwendung mit den für einen sicheren Betrieb erforderlichen Schutzeinrichtungen ausgerüstet sein (§4 Abs. 2). Diese Forderungen gelten als erfüllt, wenn:

- der Fernverriegelungsstecker eines Lasers der Klasse 3B oder 4 an einen Not-Aus-Schalter, einen Türkontakt oder an eine andere gleichwertige Einrichtung mit Schutzfunktion angeschlossen ist (§8 Abs. 4)
- Lasereinrichtungen der Klassen 2 für Unterrichtszwecke, 3R, 3B oder 4 bei Nichtbenutzung gegen unbefugten Gebrauch durch das Abnehmen des Schlüssels des Schlüsselschalters gesichert sind (§8 Abs. 4),
- Lasereinrichtungen der Klassen 3R, 3B oder 4 bei Nichtbenutzung durch die Verwendung der Strahldämpfungseinrichtungen gesichert sind (§8 Abs. 4).

Der Betrieb von Lasern der Klassen 3B oder 4 müssen dem zuständigen Unfallversicherungsträger und der für den Arbeitsschutz zuständigen Behörde vor der ersten Inbetriebnahme angezeigt werden (§5 Abs. 1).

Der Unternehmer hat für den Betrieb von Lasereinrichtungen der Klassen 3B oder 4 Sachkundige als Laserschutzbeauftragte zu bestellen (§6 Abs. 1). Es wird empfohlen, diese mit Weisungsbefugnissen und Verantwortung auszustatten (§6 Abs. 2).

Der Unternehmer hat dafür zu sorgen, dass Versicherte, die Lasereinrichtungen der Klassen 2 bis 4 anwenden oder sich in Laserbereichen von Lasereinrichtungen der Klassen 3B oder 4 aufhalten, über das zu beachtende Verhalten mindestens einmal jährlich unterwiesen werden (§8 Abs. 3).

 Z-Laser Optoelektronik GmbH Merzhauser Str. 134 D-79100 Freiburg Tel.: (0761)29644-44 Fax: (0761)29644-55/56	Product <b>ZFSM</b>	Date: <b>2017.01.24</b>	Page: <b>64 of 64</b>
	Advanced Information <b>Document-ID: UI-ZL-120005-2.0-2017-01-24</b>		Author: <b>TR</b>