

Model: ZQ1

Max. power 1.7 W	IP 67	Diode laser	Boresight error <1 mrad	Focusable	Active, integrated cooling	12 - 24 VDC	Serial communication
----------------------------	--------------	--------------------	-----------------------------------	------------------	-----------------------------------	--------------------	-----------------------------

Compact high-performance laser

The structured light laser series ZQ1 has been developed for the most demanding measurement applications in the market. Wherever a high output power, exceptional beam performance and industrial-suited design is needed, the ZQ1 series is the right choice. The user can easily adjust the right working distance for the application with its manual focus option.

The laser along with its intelligent monitoring functions enables a high stability in performance also in rough environments. The integrated active cooling system keeps the laser diode at a constant temperature. Due to its communication interfaces (RS-232 & I²C) the laser can be integrated efficiently in a sophisticated machine vision setup.

Highlights

- Repeatable high product quality due to automated production process
- Optical output power up to 1,700 mW (IR)
- Standard wavelengths from 450 – 808 nm
- Manually focusable
- Active cooling integrated
- TTL modulation up to 200 kHz
- Analog intensity control
- IP 67
- Certified according to the railway standard: DIN EN 61373:2011-04
- PC control via Graphical User Interface (GUI)

Applications

Machine Vision
3D-Measurement
Tire industry
Metrology
Road and rail inspection
Metal inspection

Order code

Z??	-	Q1	-	?	-	?	-	?
Power		Product name		F = focusable		Wavelength		Optics

SYSTEM SPECIFICATION

Wavelength	nm	450 nm	638 nm	670 nm	808 nm
Wavelength tolerance	nm (typical)	±10 nm	±6 nm	±10 nm	±4 nm
Wavelength drift	nm (temperature stabilized, over total operating temperature)	<1 nm			
Output power	mW	≤1,300 mW	≤500 mW	≤400 mW	≤1,700 mW
Spatial mode		Multi Transverse Mode			
RMS noise	(20 Hz to 20 MHz)	<0.5 %			
Peak-to-Peak Noise	(20 Hz to 20 MHz)	<1 %			
Boresight error ⁽¹⁾	mrad (in x and y)	<1 mrad			
Line orientation ⁽²⁾	mrad	<10 mrad			
Pointing stability over temp.	μrad / K	<6 μrad / K			
Emission point height ⁽³⁾	mm	28.3 mm			
Long-term power stability	(24 h)	<1 %			
Long-term power stability	(over lifetime)	<5 %			
Warm-up time	min	<2 min			
Laser operation mode		APC			

ELECTRICAL SPECIFICATION

Operating voltage		12 - 24 VDC
Operating current	(max. at 25 °C)	<4 A
Protection		Over temperature protection and LED pre-failure indicator, reverse polarity and transient protection (ESD, burst & surge)
Electrical isolation		Potential-free housing
Connection		5-pin M12 plug; 8-pin M12 plug (communication)
Power consumption		<40 W
Communication interfaces		I ² C, RS-232

OPTICAL SPECIFICATION

Fan angles ⁽⁴⁾	Degrees	5°, 10°, 20°, 30°, 45°, 60°, 75°, 90° (homogeneous line profile)
Line straightness ⁽⁵⁾	% (of line length)	<0.1 %
Line uniformity ⁽⁶⁾	% (typical)	<25 %
Dot		Point elliptical
Focus range	mm	100 mm up to 10,000 mm

KEYNOTES

⁽¹⁾ Boresight error	Also known as pitch and skew
⁽²⁾ Line orientation	Also known as roll, with reference to the ground plate
⁽³⁾ Emission point height	Offset of optical axis to ground plate
⁽⁴⁾ Line length / fan angle	at >13.5 % I _{max}
⁽⁵⁾ Line straightness	Deviation from best fit line over the middle 80% of the line, for homogeneous lines
⁽⁶⁾ Line uniformity	Maximum relative optical power variation over the middle 80% of the line, for homogeneous lines

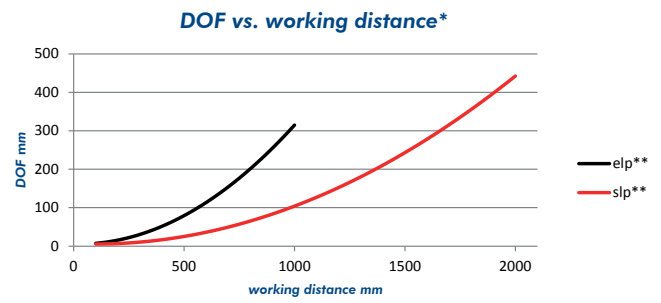
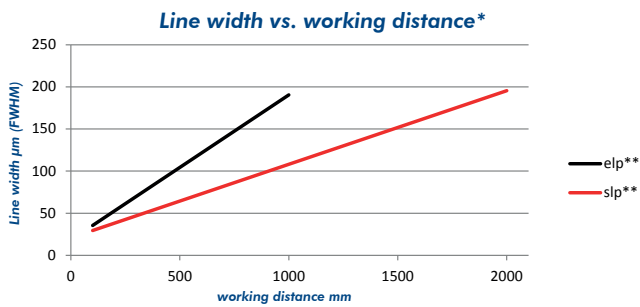

	Wavelength	Calculation factor for line width		Calculation factor for depth of focus	
		elp**	slp**	elp**	slp**
Blue	450 nm	0.90	1.03	1.03	1.78
Red	638 nm	0.98	0.90	0.90	0.98
Red	670 nm	1.00	1.00	1.00	1.00
IR	808 nm	1.16	1.14	1.14	1.24

Optical configurations for several line settings are available.

- slp** = standard line Powell; standard setup with medium line width and depth of focus

- elp** = extended line Powell; lines with advanced depth of focus and thicker lines

The graphs above show the values for line width and depth of focus of a 670 nm laser. To get the values for a different wavelength the factor from the table has to be multiplied by the values from the graphs.

Example: 670 nm laser focused at 1 m working distance:

line width approx. 110 µm; Depth of focus approx. 105 mm (@ slp** optic, values from the graphs)

Calculated: 450 nm laser focused at 1m working distance:

line width ca. 110 µm x 1.03 = 113 µm; Depth of focus approx. 105 mm x 1.78 = 187 mm

* Values in the graphs for homogenous line profiles.

SOFTWARE

Serial communication
I²C and RS-232

Features (e.g.):

- Status query
- Output power control
- System configuration
- Digital Modulation
- Intensity control
- weighted end of life indication

DIGITAL MODULATION

Maximum frequency	up to 200 kHz
Rise time (Mod High ⇒ 90 %)	<500 ns
Fall time (Mod Low ⇒ 10 %)	<350 ns
Signaling levels	VIL_max < +1.1 V VIH_min > +2.5 V
Operation range	0 - 30 VDC

ANALOG MODULATION

Maximum bandwidth	<10 Hz
Linearity	<5 % (from 5 % to 100 % of laser power)
Active range	0 - 2 VDC
Impedance	240 kΩ to internal VCC (3.6 V)
Operation range	0 - 30 VDC

ENVIRONMENTAL CONDITIONS

Operating temperature	°C / °F
Storage temperature	°C / °F
Humidity	%
Dissipated heat	W
Shock and vibration	

-10 °C to +50 °C / 14 °F to +122 °F
-40 °C to +85 °C / -40 °F to +185 °F
<90 %, non-condensing
Max. 35 W
According to DIN EN 61373:2011-04 Railway applications - Rolling stock equipment - Shock and vibration tests (IEC 61373:2010)

MECHANICAL SPECIFICATIONS

Weight	kg / lbs	0.69 kg / 1.52 lbs
Dimension	mm / inch	158.5 x 65.2 x 51.5 mm / 6.24 x 2.57 x 2.07 in
Diameter head Ø	mm / inch	20 mm / 0.79 in
Material		Aluminum (black anodized/blue-lacquered), Optic head: stainless steel
Protection class		IP 67
Mounting		4x M4 screws

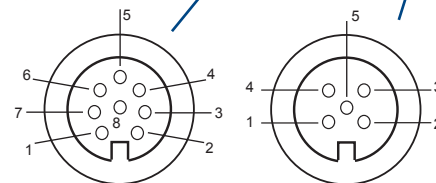
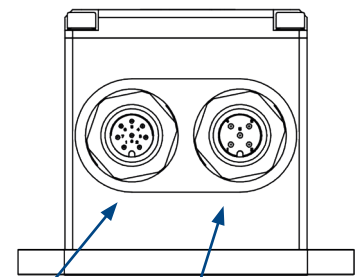
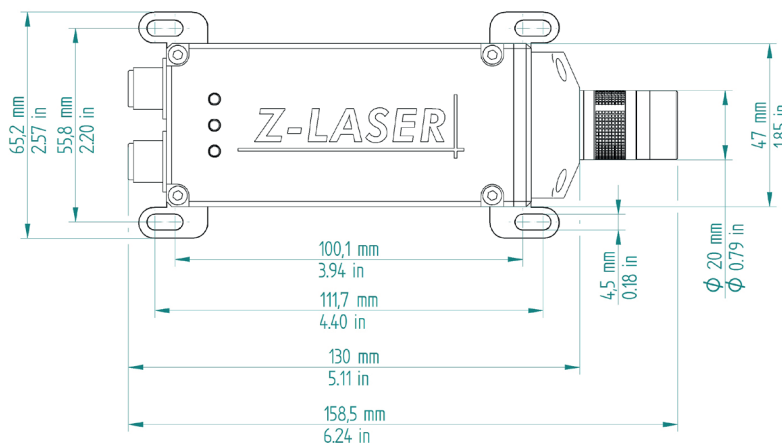
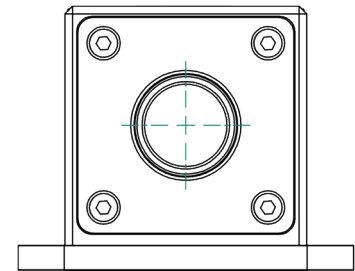
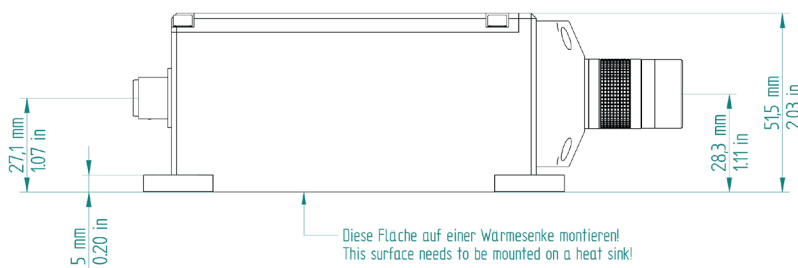

M12 8-Pin: A-Coding Male Connector

According to IEC 61076-2-101

X 2.1	RX IN (RS-232)
X 2.2	TX OUT (RS-232)
X 2.3	SCL (I ² C)
X 2.4	SDA (I ² C)
X 2.5	RDY FAIL OUT
X 2.6	System Enable OUT
X 2.7	GND
x 2.8	System Enable IN

M12 5-Pin: A-Coding Male Connector

According to IEC 61076-2-101

X 1.1	12-24 VDC, 40 VA
X 1.2	Digital-Modulation TTL
X 1.3	GND
X 1.4	Analog-Modulation (0-2 VDC)
X 1.5	Fail out (open-drain)